

idronord

Dal 1987 non manchiamo d'ingegno!

Full of genius since 1987!

25° ANNO



SETTEMBRE

2 0 1 1



Idronord, azienda nata negli anni '80, forte della sua pluriennale esperienza nella distribuzione di minuteria idraulica rappresenta un punto di riferimento importante nel proprio segmento di mercato nazionale ed internazionale.

Il costante adeguamento della propria gamma di articoli permette all'azienda di poter offrire un pacchetto di prodotti completo per le esigenze dei clienti più qualificati.

La nuova e moderna struttura del magazzino potrà soddisfare le aspettative e le richieste della clientela in termini di celerità di consegna dei prodotti e di servizio post-vendita.

Idronord, founded in the eighties, represents a very important reference point for national and foreign market, due to the long experience achieved by the distribution of accessories and fittings in hydraulic field.

The range of articles is constantly up to dated so that we can really satisfy the requirements of the most qualified clients.

The new and modern structured warehouse could guarantee an efficient and punctual delivery service so as an after sale assistance.

CONDIZIONI GENERALI DI VENDITA E DI CONSEGNA

Validità

Le presenti condizioni di vendita, di consegna e di pagamento sono valide per tutte le vendite di prodotti di Idronord.

Accettazione, modifica e annullamento dell'ordine

L'accettazione dell'ordine, comunque acquisito, è subordinata all'approvazione di Idronord tramite l'invio della fattura proforma. Il valore minimo dell'ordine deve essere superiore a 250 euro. Gli ordini possono essere annullati solo previo accordi con Idronord e i relativi costi verranno fatturati.

Trasporto

Il trasporto è a carico del Committente; ogni spedizione eseguita da Idronord avviene per incarico e conto del Committente. Spetta quindi al Committente, nel suo interesse, fare reclamo al Vettore all'atto della ricezione, per ritardi, disguidi, rotture, furti, ammanchi che si verificassero per qualsiasi causa. Non si sostituisce né si accredita la merce manomessa, danneggiata o perduta durante il trasporto. La clausola "franco destino", se preventivamente concordata, riguarda soltanto l'onere economico del trasporto.

Consegna

La merce viaggia sempre a rischio del Committente, anche se venduta franco destino.

Termini di consegna

Il termine di consegna o di spedizione ha valore semplicemente indicativo e non impegnativo e pertanto non si assumono responsabilità nei ritardi o per la mancata consegna. L'evasione parziale dell'ordine non sposta i termini della relativa fattura.

Prezzi

I prezzi possono subire variazioni nel decorso del tempo e si intendono validi e da applicare solo quelli in vigore all'atto della consegna del materiale.

Pagamento

Si riconoscono liberatori i pagamenti effettuati a mezzo banca con bonifico diretto o contro ricevuta bancaria. I pagamenti a mezzo di assegni circolari e bancari saranno liberatori ad avvenuto buon fine degli stessi. I termini di pagamento si intendono sempre tassativi. Trascorso il termine di pagamento indicato in fattura verranno addebitati gli interessi di mora nella misura prevista dal D.L. n° 231 del 9/10/2002, in attuazione della direttiva

2000/35/CE che regola i ritardi di pagamento nelle transazioni commerciali. Idronord si riserva anche, in applicazione della generale eccezione di inadempimento di cui all'articolo 1460 c.c., il diritto di sospendere o di annullare forniture in corso di spedizione ed ogni altro eventuale ordine già accettato, qualora i pagamenti non siano effettuati nei termini convenuti. Eventuali contestazioni di qualsiasi natura non conferiscono al Committente alcun diritto di sospendere i pagamenti.

Imballaggi

Le caratteristiche dell'imballo saranno di esclusiva scelta di Idronord, che si riserva di addebitare il costo al Committente.

Responsabilità

I materiali difettosi potranno, previa autorizzazione, essere restituiti a Idronord a spese del Committente. Se dall'esame risulterà che il difetto è imputabile a Idronord sarà rimborsato l'intero importo della merce resa e l'eventuale spesa di trasporto sostenuta dal Committente per la restituzione del materiale. Per quanto non indicato esplicitamente si fa riferimento alla Direttiva Europea Garanzie 1999/44/CE.

Reclami

Ogni fornitura si intende accettata trascorsi senza reclami 8 giorni dal ricevimento della merce.

Numero di codice

I prodotti dovranno essere ordinati con numero di codice di identificazione.

Identità

Il Committente è responsabile di tutti i dati e delle informazioni di identificazione forniti a Idronord quali nominativo, ragione sociale, indirizzo, codice di identificazione fiscale e quant'altro specificatamente richiesto dalla legislazione vigente.

Fido

Idronord si riserva di apportare modifiche al fido eventualmente assegnato ogni qualvolta lo riterrà opportuno a suo insindacabile giudizio.

Foro competente

Per qualsiasi controversia tra Idronord e il Committente sarà sempre e solo competente il Foro di Bergamo.

I prezzi del presente listino si intendono IVA esclusa.

INDICE DEI CAPITOLI

CHAPTERS' INDEX

Guarnizioni per idraulica e riscaldamento pag. 7 Gaskets for hydraulic and heating systems	1
Accessori vari e fissaggi » 21 Accessories and fixing	2
Raccorderia » 31 Fittings	3
Raccordi per scarichi » 41 Fittings for outlet pipe	4
Complementi per impianti idraulici » 45 Accessories for hydraulic systems	5
Valvolame e rubinetteria » 60 Valves and faucets	6
Complementi per cassette di scarico » 69 Accessories for wc cistern	7
Attacchi e flessibili per acqua, gas e condizionamento » 76 Connections and flexibles for water, gas and conditioning	8
Serie miscelatori ed accessori per doccia e bagno » 84 Mixers and accessories for shower and bath	9
Sigillanti e prodotti termici » 109 Sealers and thermal products	10

INDICE DEI PRODOTTI

PRODUCTS' INDEX

1

GUARNIZIONI PER IDRAULICA E RISCALDAMENTO

pag. 7

Guarnizioni

Aste e sfere per galleggianti

Membrane per idrosfere

Morsetti

O'Ring

2

ACCESSORI VARI E FISSAGGI

pag. 21

Tappi livello

Pull

Griglie per livello

Tappi saltarello

Canne livello

Aeratori

Eccentrici

Viti di fissaggio

Mensole livello

Supporti per sedili wc

Collari

Tappi e riduzioni per radiatore

Mensole per radiatore

Eccentrici per radiatore

Resistenze scaldabagno

Valvole di sicurezza per scaldabagno

Manometri

3

RACCORDERIA

pag. 31

Raccorderia in ottone

Raccorderia in ferro zincato

Tappi prova impianto

4

RACCORDI PER SCARICHI

pag. 41

Tubi per scarico wc

Starflex

Manicotti wc

Protezione per wc

5

COMPLEMENTI PER IMPIANTI IDRAULICI

pag. 45

Sifoni in ottone

Sifoni in plastica

Pilette

Riduzioni in plastica

Raccordi portagomma

Colonne vasca

Sifoni lavatrice

Tubi per lavatrice

Tappi per pozzetto

Copriforo

Canotti in ottone

Rosoni in ottone

Rosoni in plastica per radiatori

6

VALVOLAME E RUBINETTERIA

pag. 60

Curvette sottolavabo

Curvetta per saliscendi

Rubinetto filtro

Rubinetto per cassetta

Rubinetto lavatrice

Rubinetto per livello

Distanziatori

Rubinetto portagomma

Rubinetto artistico

Valvole a sfera

Blister pronto intervento

Vitoni

7**COMPLEMENTI
PER CASSETTE DI SCARICO**
pag. 69

Rubinetti galleggianti

Sfere galleggianti

Tubi di cacciata

Ricambi per cassetta wc

8**ATTACCHI E FLESSIBILI
PER ACQUA, GAS
E CONDIZIONAMENTO**
pag. 76

Rotoli rame

Barre rame

Flessibili acqua

Flessibili gas

Rubinetti gas

Raccordi portagomma gas

Tubi gas

Guaine gas

Tubi scarico condensa

Cassetta da incasso per condizionatore

Mensole di sostegno condizionatore

9**SERIE MISCELATORI
ED ACCESSORI
PER DOCCIA E BAGNO**
pag. 84

Soffioni doccia

Bracci doccia

Doccette

Saliscendi

Flessibili doccia

Miscelatori

Accessori bagno

Maniglioni per disabili

Copriwater

Supporti per copriwater

Paracolpi per copriwater

10**SIGILLANTI
E PRODOTTI TERMICI**
pag. 109

Pasta

Stucco

Stearina

Mastice

Bende

Detergenti per condizionatori

Antigelo

Silicone

Teflon

Canapa

Sturalavabi



RINA
www.rina.org

CISQ is a member of



www.ionet-certification.com

IONet, the association of the world's first class certification bodies, is the largest provider of management system Certification in the world. IONet is composed of more than 30 bodies and counts over 150 subsidiaries all over the globe.

Per informazioni sulla validità del certificato, visitare il sito www.rina.org

For information concerning validity of the certificate, you can visit the site www.rina.org

CERTIFICATO N. 646/97/S
CERTIFICATE No.

SI CERTIFICA CHE IL SISTEMA DI GESTIONE PER LA QUALITÀ DI
IT IS HEREBY CERTIFIED THAT THE QUALITY MANAGEMENT SYSTEM OF

IDRO TRADE S.P.A. - DIVISIONE IDRONORD

VIA DELLA MADONNA, 2 24040 LALLIO (BG) ITALIA

NELLE SEGUENTI UNITÀ OPERATIVE / IN THE FOLLOWING OPERATIONAL UNITS

VIA DELLE INDUSTRIE, 83 20040 CAMBIAGO (MI) ITALIA

È CONFORME ALLA NORMA / IS IN COMPLIANCE WITH THE STANDARD

ISO 9001:2008

PER I SEGUENTI CAMPI DI ATTIVITÀ / FOR THE FOLLOWING FIELD(S) OF ACTIVITIES

COMMERCIO ALL'INGROSSO DI ACCESSORI E MINUTERIA PER L'IDRAULICA ED IL RISCALDAMENTO

EA:29A

WHOLESALE TRADE OF ACCESSORIES AND SMALL PARTS FOR HYDRAULICS AND HEATING

Riferirsi al Manuale della Qualità per i dettagli delle esclusioni ai requisiti della norma

Reference is to be made to the Quality Manual for details regarding the exemptions from the requirements of the standard

La validità del presente certificato è subordinata a sorveglianza periodica annuale / semestrale ed al riesame completo del sistema di gestione con periodicità triennale

The validity of this certificate is dependent on an annual / six monthly audit and on a complete review, every three years, of the management system

L'uso e la validità del presente certificato sono soggetti al rispetto del documento RINA: Regolamento per la Certificazione di Sistemi di Gestione per la Qualità

The use and validity of this certificate are subject to compliance with the RINA document: Rules for the certification of Quality Management Systems

Prima emissione First Issue	10.06.1997
Emissione corrente Current Issue	29.07.2010
Data scadenza Expiry Date	10.06.2012

Dott. Roberto Cavanna
(Direttore della Divisione Certificazione)

RINA Services S.p.A.
Via Corsica 12 - 16128 Genova Italy

CISQ è la Federazione Italiana di Organismi di Certificazione dei sistemi di gestione aziendale

CISQ is the Italian Federation of management system Certification Bodies



SGQ N° 002A - SGA N° 002D
PRD N° 002B - PRS N° 006C
SCR N° 003F - SSI N° 001G

Membro degli Accordi di Mutuo Riconoscimento EA e IAF
Signatory of EA and IAF Mutual Recognition Agreements



GUARNIZIONI PER IDRAULICA E RISCALDAMENTO

GASKETS FOR HYDRAULIC AND HEATING SYSTEMS



Guarnizione in gomma stampata "Star 67 per rubinetto"

Rubber gasket "Star 67"
with hole for tap

cod.	misura	pz. x conf.	euro cad.
300000000C	3/8"	100	0,072
300000000D	1/2"	100	0,084
300000000F	3/4"	50	0,200
300000000G	1"	25	0,156



Guarnizione in gomma da manicotto per rubinetto

Rubber gasket
with hole for tap

cod.	misura	pz. x conf.	euro cad.
400000000C	3/8"	100	0,032
400000000D	1/2"	100	0,040
400000000F	3/4"	50	0,084



Guarnizione in gomma semiforata per rubinetto

Rubber gasket
with half hole for tap

cod.	misura	pz. x conf.	euro cad.
4000SF000C	3/8"	100	0,040
4000SF000D	1/2"	100	0,052
4000SF000F	3/4"	50	0,116



Guarnizione "new eco" per rubinetto

Gasket "new eco" for tap

cod.	misura	pz. x conf.	euro cad.
399900000C	3/8"	100	0,156
399900000D	1/2"	100	0,156
399900000F	3/4"	50	0,320

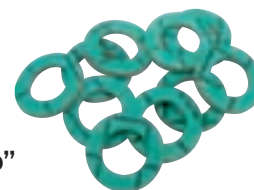

Guarnizione "esente amianto" 2 mm per raccordo sanitario

Asbestos free gasket
2 mm for sanitary connection

cod.	misura	pz. x conf.	euro cad.
1086ESE00B	1/4"	100	0,036
1086ESE00C	3/8"	100	0,012
1086ESE00D	1/2"	100	0,016
1086ESE00F	3/4"	100	0,024
1086ESE00G	1"	100	0,028
1086ESE0GB	1"1/4	100	0,060
1086ESE0GD	1"1/2	100	0,076
1086ESE00H	2"	100	0,152
1086ESE0HD	2"1/2	100	0,216



Guarnizione "Klinger sil" 2 mm per raccordo sanitario

Gasket "Klinger sil"
2 mm for sanitary connection

cod.	misura	pz. x conf.	euro cad.
1086ER000C	3/8"	100	0,040
1086ER000D	1/2"	100	0,076
1086ER000F	3/4"	100	0,112
1086ER000G	1"	100	0,112
1086ER00GB	1"1/4	100	0,224
1086ER00GD	1"1/2	100	0,252
1086ER000H	2"	100	0,376



**Guarnizione
in gomma nera 2 mm
per raccordo sanitario**
Black rubber gasket 2 mm
for sanitary connection

cod.	misura	pz. x conf.	euro cad.
1086NT000C	3/8"	100	0,012
1086NT000D	1/2"	100	0,012
1086NT000F	3/4"	100	0,020
1086NT000G	1"	100	0,036
1086NT000GB	1"1/4	100	0,056
1086NT000GD	1"1/2	100	0,064
1086NT000H	2"	100	0,084



**Guarnizione in fibra rossa
per raccordo sanitario**
Red fiber gasket for sanitary
connection

cod.	misura	pz. x conf.	euro cad.
1086FI000C	3/8"	100	0,012
1086FI000D	1/2"	100	0,012
1086FI000F	3/4"	100	0,020
1086FI000G	1"	100	0,024
1086FI000GB	1"1/4	100	0,040
1086FI000GD	1"1/2	100	0,056



**Guarnizione in Teflon 2 mm
per raccordo sanitario**
Teflon gasket 2 mm for sanitary
connection

cod.	misura	pz. x conf.	euro cad.
1086T0000C	3/8"	100	0,092
1086T0000D	1/2"	100	0,120
1086T0000F	3/4"	100	0,144
1086T0000G	1"	100	0,172
1086T0000GB	1"1/4	100	0,784
1086T0000GD	1"1/2	100	1,008



Guarnizione in alluminio
Aluminium gasket

cod.	misura	pz. x conf.	euro cad.
5029GUAR0D	1/2"	100	0,276
5029GUAR0F	3/4"	100	0,300



**Guarnizione gomma nera
2 mm per carico lavatrice**
Black rubber gasket 2 mm for inlet
pipe washing machine

cod.	misura	pz. x conf.	euro cad.
1342NT0000	3/4"	100	0,032



**Filtro retinato per tubo
carico lavatrice**
Screened filter for inlet pipe
washing machine

cod.	misura	pz. x conf.	euro cad.
1313RET000	3/4"	100	0,280
1313RET00D	1/2"	100	0,240



**Guarnizione
per aereatore**
Gasket for aerator

cod.	misura	pz. x conf.	euro cad.
1313GUAR00	m 24x1	100	0,060
1314GUAR00	f 22x1	100	0,060
1317GUAR00	m 28x1	100	0,076



**Guarnizione in gomma
a scodellino per
rubinetto galleggiante**
Rubber gasket with shape
"cap" for floating valve

cod.	misura	pz. x conf.	euro cad.
1092000017	17 mm	100	0,068
10920018.5	18,5 mm	100	0,048
1092000021	21 mm	100	0,084
1092000023	23 mm	100	0,124
1092000024	24 mm	100	0,100
1092000029	29 mm	100	0,180
1092000040	40 mm	100	0,464

Guarnizione in gomma piana per rubinetto galleggiante

Flat rubber gasket for floating valve



cod.	misura	pz. x conf.	euro cad.
1091000009	9 mm	100	0,036
1091000010	10 mm	100	0,036
1091000011	11 mm	100	0,048
1091000012	12 mm	100	0,056
1091000013	13 mm	100	0,060
1091000014	14 mm	100	0,084
1091000015	15 mm	100	0,112
1091000017	17 mm	100	0,132
1091000018	18 mm	100	0,132
1091000020	20 mm	100	0,136

Guarnizioni in gomma sintetica per raccordi contatori tenuta acqua 110°C

Synthetic rubber gasket for counter connectors 110°C waterseal



cod.	misura	pz. x conf.	euro cad.
1090G0000D	23,5x16 -1/2"	100	0,044
1090G0000F	30x20 -3/4"	100	0,084
1090G0000G	38x25 -1"	100	0,076
1090G0000GB	44x32 -1"1/4	100	0,112
1090G0000GD	55x38 -1"1/2	100	0,124

Guarnizioni in gomma sintetica per tenuta gas a norme UNI 9264

Synthetic rubber gasket for gas seal under standard UNI 9264



cod.	misura	pz. x conf.	euro cad.
1086GAS00D	18,5x12 -1/2"	100	0,060
1086GAS00F	24,3x18 -3/4"	100	0,068
1086GAS00G	30x23 -1"	100	0,080
1086GASCOG	29x23 -1" cont	100	0,080
1086GAS0GB	38,5x30,5 -1"1/4	100	0,096
1086GASCGB	38x31,5 -1"1/4 cont	100	0,096
1086GAS0GD	44x33,5 -1"1/2	100	0,128

Guarnizione per riduttori pressione GPL

Gasket for GPL pressure reducer in cork and nbr



cod.	misura	pz. x conf.	euro cad.
5020000000	sughero 17x10x2	100	0,040
5020G00000	nbr 1/2" 17x10,5	100	0,048

Guarnizione conica in gomma nera

Black rubber conic gasket



cod.	misura	pz. x conf.	euro cad.
1087000C10	10x3/8" mm	100	0,032
1087000D10	10x1/2" mm	100	0,048
1087000D12	12x1/2" mm	100	0,052
1087000D14	14x1/2" mm	100	0,052
1087000018	18 mm	100	0,080
1087000026	26 mm	100	0,096
1087000030	30 mm	100	0,132
1087000032	32 mm	100	0,144
1087000040	40 mm	100	0,200
1087000050	50 mm	100	0,260

Guarnizione conica in pvc nera

Black pvc conic gasket



cod.	misura	pz. x conf.	euro cad.
60150000GB	1x1"1/4	50	0,352
601500GDGB	1"1/2x1"1/4	50	0,352

Guarnizione "esente amianto" 2 mm per bocchettone

Asbestos free gasket 2 mm for pipe union



cod.	misura	pz. x conf.	euro cad.
1088ESE200C	3/8"	100	0,032
1088ESE200D	1/2"	100	0,052
1088ESE200F	3/4"	100	0,064
1088ESE200G	1"	100	0,096
1088ESE20GB	1"1/4	100	0,148
1088ESE20GD	1"1/2	100	0,236
1088ESE20H	2"	100	0,292
1088ESE2HD	2"1/2	100	0,540
1088ESE20I	3"	100	1,104

Guarnizione "esente amianto" 2 mm giapponese per bocchettone

Asbestos free gasket japan type 2 mm for pipe union



cod.	misura	pz. x conf.	euro cad.
1088ESE200DG	1/2"	100	0,048
1088ESE200FG	3/4"	100	0,056
1088ESE200GG	1"	100	0,084
1088ESE20GBG	1"1/4	100	0,120
1088ESE20GDG	1"1/2	50	0,180
1088ESE20HG	2"	50	0,228

**Guarnizione "esente
amianto" per flangia
2 mm PN 10 / PN 16**

Asbestos free gasket 2 mm
PN 10 / PN 16 for flange



cod.	misura	pz. x conf.	euro cad.
1089ESE015	dn 15	50	0,152
1089ESE020	dn 20	50	0,188
1089ESE025	dn 25	50	0,256
1089ESE032	dn 32	50	0,308
1089ESE040	dn 40	50	0,396
1089ESE050	dn 50	50	0,620
1089ESE065	dn 65	50	0,892
1089ESE080	dn 80	50	1,104
1089ESE100	dn 100	50	1,424
1089ESE125	dn 125	50	1,824
1089ESE150	dn 150	50	2,172
1089ESE175	dn 175	50	2,872
1089ESE200	dn 200	50	3,436

2 mm PN 6

2 mm PN6

cod.	misura	pz. x conf.	euro cad.
1089E60015	dn 15	50	0,152
1089E60020	dn 20	50	0,188
1089E60025	dn 25	50	0,256
1089E60032	dn 32	50	0,308
1089E60040	dn 40	50	0,396
1089E60050	dn 50	50	0,620
1089E60065	dn 65	50	0,892
1089E60080	dn 80	50	1,104
1089E60100	dn 100	50	1,424
1089E60125	dn 125	50	1,824
1089E60150	dn 150	50	2,172
1089E60175	dn 175	50	2,872
1089E60200	dn 200	50	3,436

3 mm PN 10 / PN 16

3 mm PN10 / PN 16

cod.	misura	pz. x conf.	euro cad.
1089E30015	dn 15	25	0,224
1089E30020	dn 20	25	0,320
1089E30025	dn 25	25	0,416
1089E30032	dn 32	25	0,592
1089E30040	dn 40	25	0,764
1089E30050	dn 50	25	1,016
1089E30065	dn 65	25	1,480
1089E30080	dn 80	25	1,484
1089E30100	dn 100	25	2,188
1089E30125	dn 125	25	3,052
1089E30150	dn 150	25	3,476
1089E30175	dn 175	25	3,984
1089E30200	dn 200	25	4,832

3 mm PN 6

3 mm PN6

cod.	misura	pz. x conf.	euro cad.
1089E63015	dn 15	25	0,224
1089E63020	dn 20	25	0,320
1089E63025	dn 25	25	0,416
1089E63032	dn 32	25	0,592
1089E63040	dn 40	25	0,764
1089E63050	dn 50	25	1,016
1089E63065	dn 65	25	1,480
1089E63080	dn 80	25	1,484
1089E63100	dn 100	25	2,188
1089E63125	dn 125	25	3,052
1089E63150	dn 150	25	3,476
1089E63175	dn 175	25	3,984
1089E63200	dn 200	25	4,832

**Guarnizione flangia
"fasit omnia"
2 mm PN 10 / PN 16**

Gasket "fasit omnia"
2 mm PN 10 / PN 16 for flange



cod.	misura	pz. x conf.	euro cad.
1089/O0015	dn 15	50	0,380
1089/O0020	dn 20	50	0,468
1089/O0025	dn 25	50	0,592
1089/O0032	dn 32	50	0,744
1089/O0040	dn 40	50	0,976
1089/O0050	dn 50	50	1,316
1089/O0065	dn 65	50	1,968
1089/O0080	dn 80	50	2,380
1089/O0100	dn 100	50	3,024
1089/O0125	dn 125	50	3,828
1089/O0150	dn 150	50	4,864
1089/O0175	dn 175	50	7,632
1089/O0200	dn 200	50	9,496

2 mm PN 6

2 mm PN 6

cod.	misura	pz. x conf.	euro cad.
1089/O6015	dn 15	50	0,380
1089/O6020	dn 20	50	0,468
1089/O6025	dn 25	50	0,592
1089/O6032	dn 32	50	0,744
1089/O6040	dn 40	50	0,976
1089/O6050	dn 50	50	1,316
1089/O6065	dn 65	50	1,968
1089/O6080	dn 80	50	2,380
1089/O6100	dn 100	50	3,024
1089/O6125	dn 125	50	3,828
1089/O6150	dn 150	50	4,864
1089/O6175	dn 175	50	7,632
1089/O6200	dn 200	50	9,496

3 mm PN 10 / PN 16

3 mm PN 10 / PN 16

cod.	misura	pz. x conf.	euro cad.
1089/03015	dn 15	25	0,468
1089/03020	dn 20	25	0,624
1089/03025	dn 25	25	0,856
1089/03032	dn 32	25	1,016
1089/03040	dn 40	25	1,168
1089/03050	dn 50	25	2,500
1089/03065	dn 65	25	2,840
1089/03080	dn 80	25	3,548
1089/03100	dn 100	25	5,088
1089/03125	dn 125	25	6,700
1089/03150	dn 150	25	8,056
1089/03175	dn 175	25	8,904
1089/03200	dn 200	25	11,024

3 mm PN 6

3 mm PN 6

cod.	misura	pz. x conf.	euro cad.
1089/036015	dn 15	25	0,468
1089/036020	dn 20	25	0,624
1089/036025	dn 25	25	0,856
1089/036032	dn 32	25	1,016
1089/036040	dn 40	25	1,168
1089/036050	dn 50	25	2,500
1089/036065	dn 65	25	2,840
1089/036080	dn 80	25	3,548
1089/036100	dn 100	25	5,088
1089/036125	dn 125	25	6,700
1089/036150	dn 150	25	8,056
1089/036175	dn 175	25	8,904
1089/036200	dn 200	25	11,024

Guarnizione flangia in gommata 3 mm PN 10 / PN 16

Friction gasket 3 mm PN 10 / PN 16 for flange

cod.	misura	pz. x conf.	euro cad.
1089GT3015	dn 15	25	0,124
1089GT3020	dn 20	25	0,164
1089GT3025	dn 25	25	0,192
1089GT3032	dn 32	25	0,240
1089GT3040	dn 40	25	0,276
1089GT3050	dn 50	25	0,328
1089GT3065	dn 65	25	0,484
1089GT3080	dn 80	25	0,604
1089GT3100	dn 100	25	0,752
1089GT3125	dn 125	25	1,016
1089GT3150	dn 150	25	1,188
1089GT3175	dn 175	25	1,652
1089GT3200	dn 200	25	2,100



3 mm PN 6

3 mm PN 6

cod.	misura	pz. x conf.	euro cad.
1089GT36015	dn 15	25	0,124
1089GT36020	dn 20	25	0,164
1089GT36025	dn 25	25	0,192
1089GT36032	dn 32	25	0,240
1089GT36040	dn 40	25	0,276
1089GT36050	dn 50	25	0,328
1089GT36065	dn 65	25	0,484
1089GT36080	dn 80	25	0,604
1089GT36100	dn 100	25	0,752
1089GT36125	dn 125	25	1,016
1089GT36150	dn 150	25	1,188
1089GT36175	dn 175	25	1,652
1089GT36200	dn 200	25	2,100

Guarnizione flangia per vapore 3 mm PN 10 / PN 16

Black gasket 3 mm PN 10 / PN 16 for steam flange

cod.	misura	pz. x conf.	euro cad.
1089/VN015	dn 15	25	0,636
1089/VN020	dn 20	25	0,932
1089/VN025	dn 25	25	1,228
1089/VN032	dn 32	25	1,612
1089/VN040	dn 40	25	2,120
1089/VN050	dn 50	25	2,332
1089/VN065	dn 65	25	3,392
1089/VN080	dn 80	25	4,028
1089/VN100	dn 100	25	5,088
1089/VN125	dn 125	25	5,512
1089/VN150	dn 150	25	8,056
1089/VN175	dn 175	25	10,600
1089/VN200	dn 200	25	12,084



3 mm PN 6

3 mm PN 6

cod.	misura	pz. x conf.	euro cad.
1089/VN6015	dn 15	25	0,636
1089/VN6020	dn 20	25	0,932
1089/VN6025	dn 25	25	1,228
1089/VN6032	dn 32	25	1,612
1089/VN6040	dn 40	25	2,120
1089/VN6050	dn 50	25	2,332
1089/VN6065	dn 65	25	3,392
1089/VN6080	dn 80	25	4,028
1089/VN6100	dn 100	25	5,088
1089/VN6125	dn 125	25	5,512
1089/VN6150	dn 150	25	8,056
1089/VN6175	dn 175	25	10,600
1089/VN6200	dn 200	25	12,084

**Guarnizione in cartoncino
0,5 mm per radiatore**

Card board gasket 0,5 mm for radiator

cod.	misura	pz. x conf.	euro cad.
1094C0000G	1"	100	0,012
	rad. ghisa		
1094C000GB	1"1/4	100	0,016
	rad. ghisa		
1094CAL00G	1"	100	0,012
	rad. alluminio		
1094CAL0GB	1"1/4	100	0,016
	rad. alluminio		



**Guarnizione per radiatore
in alluminio "esente
amianto" 1 mm**

Abestos free gasket 1 mm
for aluminium radiator

cod.	misura	pz. x conf.	euro cad.
1094AE000G	1"	100	0,068
1094AE00GB	1"1/4	100	0,104



2 mm

2 mm

cod.	misura	pz. x conf.	euro cad.
1094AE200G	1"	100	0,076
1094AE20GB	1"1/4	100	0,100

**Guarnizione per radiatore
in ghisa "esente amianto" 1 mm**

Abestos free gasket 1 mm
for cast ironed radiator

cod.	misura	pz. x conf.	euro cad.
1094GE000G	1"	100	0,096
1094GE00GB	1"1/4	100	0,112

2 mm

2 mm

cod.	misura	pz. x conf.	euro cad.
1094GE200G	1"	100	0,108
1094GE20GB	1"1/4	100	0,124

**Guarnizione epdm 3 mm
radiatore in acciaio**

Gasket in epdm 3 mm
for steel radiator

cod.	misura	pz. x conf.	euro cad.
1094AEA0GB	1"1/4	100	0,364



**Guarnizione in epdm 1,5 mm
radiatore in alluminio**

Gasket in epdm 1,5 mm
for aluminium radiator

cod.	misura	pz. x conf.	euro cad.
1094AEPD0G	1"	100	0,128

2,5 mm

2,5 mm

cod.	misura	pz. x conf.	euro cad.
1094AEPD2G	1"	100	0,248

**Guarnizione conica sotto
piletta con filetto in gomma bianca**

White rubber conic gasket
with thread under pop up

cod.	misura	pz. x conf.	euro cad.
107700000D	1/2"	100	0,336
107700000F	3/4"	100	0,808
107700000G	1"	100	0,540
1077GBVASC	1"1/4	100	0,792
1077GDSIFO	1"1/2	50	0,968



**Guarnizione conica sotto
piletta senza filetto in gomma bianca**

White rubber conic gasket
without thread under pop up

cod.	misura	pz. x conf.	euro cad.
1077SF000D	1/2"	100	0,228
1077SF000F	3/4"	100	0,484
1077SF000G	1"	100	0,388
1077SFGBVA	1"1/4	100	0,388
1077SFGDSI	1"1/2	50	0,648



Guarnizione piana sotto piletta in gomma bianca 1 mm

Flat white rubber thin gasket
1 mm under pop up



cod.	misura	pz. x conf.	euro cad.
107900000D	1/2"	100	0,248
107900000F	3/4"	100	0,404
107900000G	1"	100	0,404
1079GBVASC	1"1/4	100	0,484
1079GDSIFO	1"1/2	100	0,608

Guarnizione sotto piletta in gomma bianca con bordino

White rubber gasket
with flange under pop up



cod.	misura	pz. x conf.	euro cad.
108000000D	1/2"	100	0,208
108000000F	3/4"	100	0,324
108000000G	1"	100	0,320
1080GBVASC	1"1/4	100	0,588
1080GDSIFO	1"1/2	100	0,628

Serie guarnizioni a 2 pz. sotto piletta in gomma bianca con bordino

Set of 2 pieces white rubber gasket
with flange under pop up



cod.	misura	pz. x conf.	euro cad.
1080/2P00D	1/2"	50	0,764
1080/2P00F	3/4"	50	1,036
1080/2P00G	1"	50	1,028
1080/2PGBV	1"1/4	50	1,388
1080/2PGDS	1"1/2	50	1,548

Serie guarnizioni a 3 pz. sotto piletta in gomma bianca con bordino

Set of 3 pieces white rubber gasket
with flange under pop up



cod.	misura	pz. x conf.	euro cad.
1080/3P00D	1/2"	25	1,012
1080/3P00F	3/4"	25	1,368
1080/3P00G	1"	25	1,368
1080/3PGBV	1"1/4	25	1,852
1080/3PGDS	1"1/2	25	1,996

Serie guarnizioni a 4 pz. con guarnizione sotto piletta in gomma bianca con bordino

Set of 4 pieces white rubber gasket with thread under pop up



cod.	misura	pz. x conf.	euro cad.
1080/4P00D	1/2"	25	1,144
1080/4P00F	3/4"	25	1,592
1080/4P00G	1"	25	1,608
1080/4PGBV	1"1/4	25	2,104
1080/4PGDS	1"1/2	25	2,280

Serie guarnizioni a 2 pz. con guarnizione conica senza filetto in gomma bianca

Set of 2 pieces white rubber gasket without thread



cod.	misura	pz. x conf.	euro cad.
1078SF000D	1/2"	50	0,872
1078SF000F	3/4"	50	1,244
1078SF000G	1"	50	1,144
1078SFGBVA	1"1/4	50	1,188
1078SFGBSI	1"1/2	50	1,592

Serie guarnizioni a 3 pz. con guarnizione conica senza filetto in gomma bianca

Set of 3 pieces white rubber gasket without thread



cod.	misura	pz. x conf.	euro cad.
1078SF3P0D	1/2"	25	1,080
1078SF3P0F	3/4"	25	1,528
1078SF3P0G	1"	25	1,440
1078SF3PVA	1"1/4	25	1,640
1078SF3PSI	1"1/2	25	2,024

Serie guarnizioni a 4 pz. con guarnizione conica senza filetto in gomma bianca

Set of 4 pieces white rubber gasket without thread



cod.	misura	pz. x conf.	euro cad.
1078SF4P0D	1/2"	25	1,224
1078SF4P0F	3/4"	25	1,752
1078SF4P0G	1"	25	1,672
1078SF4PVA	1"1/4	25	1,900
1078SF4PSI	1"1/2	25	2,316

**Serie guarnizioni a 2 pz.
con guarnizione conica filettata
in gomma bianca**



Set of 2 pieces white rubber gasket

cod.	misura	pz. x conf.	euro cad.
107800000D	1/2"	50	0,896
107800000F	3/4"	50	1,520
107800000G	1"	50	1,256
1078GBVASC	1"1/4	50	1,596
1078GDSIFO	1"1/2	50	1,884

**Serie guarnizioni a 3 pz.
con guarnizione conica
filettata in gomma bianca**



Set of white rubber gasket 3 pieces

cod.	misura	pz. x conf.	euro cad.
1078/3P00D	1/2"	25	1,144
1078/3P00F	3/4"	25	1,844
1078/3P00G	1"	25	1,588
1078/3PGBV	1"1/4	25	2,032
1078/3PGDS	1"1/2	25	2,332

**Serie guarnizioni a 4 pz.
con guarnizione conica filettata
in gomma bianca**



Set of white rubber gasket 4 pieces

cod.	misura	pz. x conf.	euro cad.
1078/4P00D	1/2"	25	1,284
1078/4P00F	3/4"	25	2,068
1078/4P00G	1"	25	1,820
1078/4PGBV	1"1/4	25	2,300
1078/4PGDS	1"1/2	25	2,612

Aste galleggianti per cassetta

Completed rod for cistern

TIPO "D"

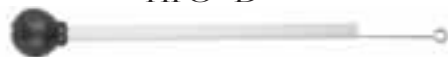

cod.	misura	pz. x conf.	euro cad.
1000LT1200	12 lt 410 mm	25	5,720
1001LT1400	14 lt 455 mm	25	5,720

TIPO "S"



cod.	misura	pz. x conf.	euro cad.
1005LT1200	12 lt 410 mm	25	6,600

TIPO "S"



cod.	misura	pz. x conf.	euro cad.
1006LT1400	14 lt 465 mm	25	6,600

TIPO "D"



cod.	misura	pz. x conf.	euro cad.
1008MM.400	12 lt 400 mm	25	5,720

TIPO "D"



cod.	misura	pz. x conf.	euro cad.
1009LT1400	14 lt 460 mm	25	5,720

TIPO "S"



cod.	misura	pz. x conf.	euro cad.
1010LT1200	12 lt 410 mm	25	6,688

TIPO "S"

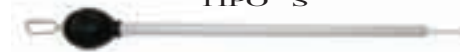

cod.	misura	pz. x conf.	euro cad.
1011LT1400	14 lt 465 mm	25	6,688

TIPO "R"



cod.	misura	pz. x conf.	euro cad.
1731000026	26 cm	25	12,148
1731000000	36 cm	25	11,928

Sfere galleggianti per cassetta

Para rubber balls for cistern



cod.	misura	pz. x conf.	euro cad.
1012000000	Ø 68 foro 22,5	25	1,744



cod.	misura	pz. x conf.	euro cad.
1014000000	Ø 65 foro 18	25	1,568



cod.	misura	pz. x conf.	euro cad.
1017000000	Ø 64,5 fil 4MA	25	1,844



cod.	misura	pz. x conf.	euro cad.
1018000000	60 mm	25	1,724



cod.	misura	pz. x conf.	euro cad.
1019000000	Ø 58 foro 15	25	1,652



cod.	misura	pz. x conf.	euro cad.
1020MM6500	65 mm	25	1,652
1020MM7000	70 mm	25	1,652



cod.	misura	pz. x conf.	euro cad.
1022000000	Ø 57,5 foro 13	25	3,704



cod.	misura	pz. x conf.	euro cad.
1025000000	Ø 62 foro 18	25	1,760



cod.	misura	pz. x conf.	euro cad.
1026000000	Ø 58 foro 15	25	1,652



cod.	misura	pz. x conf.	euro cad.
1027000000	62,5 mm	25	0,748



cod.	misura	pz. x conf.	euro cad.
1028000000	58 mm	25	1,760



cod.	misura	pz. x conf.	euro cad.
1030000000	Ø 65 foro 17	25	2,508



cod.	misura	pz. x conf.	euro cad.
1031000000	Ø 69,5 fil 5/32	25	2,092



cod.	misura	pz. x conf.	euro cad.
1032000000	Ø 67 foro 15	25	1,568



cod.	misura	pz. x conf.	euro cad.
1033MM3400	34 mm fil 4MA	50	1,044
1033MM3600	36 mm fil 4MA	50	1,236



cod.	misura	pz. x conf.	euro cad.
1033SN3400	34 mm s/not.	50	0,728



cod.	misura	pz. x conf.	euro cad.
1034000000	Ø 55 foro 14	25	1,616



cod.	misura	pz. x conf.	euro cad.
1035000000	Ø 57 foro 15	25	1,568



Guarnizioni galleggianti para
Para floated gasket

cod.	misura	pz. x conf.	euro cad.
1021000000	Ø est. mm 19,7 h 11	25	0,180



Anello in gomma per tubo di cacciata
Rubber ring for plastic tube connection

cod.	misura	pz. x conf.	euro cad.
4023000000	46x30 mm	25	0,404



Guarnizione fondo tipo pucci
Para gasket pucci type

cod.	misura	pz. x conf.	euro cad.
1037000000	60x44x10 mm	100	0,904

Serie guarnizioni tipo pucci

Completed bag with gaskets pucci type



cod.	pz. x conf.	euro cad.
1038000000	25	2,200

Guarnizione in gomma nera
Black rubber gasket



cod.	misura	pz. x conf.	euro cad.
2001/NT000	70x41x6 mm	25	0,596

Guarnizione per batteria siphonic para

Para gasket for siphonic battery



cod.	pz. x conf.	euro cad.
2001000000	25	0,712

Membrana per batteria siphonic para

Para rubber membrane for siphonic battery



cod.	misura	pz. x conf.	euro cad.
4026000000	61x22x9 mm	25	0,620

Guarnizione piana para
Para flat gasket



cod.	misura	pz. x conf.	euro cad.
1702400000	40x6x3 mm	25	0,588
170244.500	44,5x5x3 mm	25	0,548
1702500000	50x5x3 mm	25	0,656
1702050000	50x15x3 mm	25	0,588
170250X220	50x22x3 mm	25	0,588
1702540000	54x26x3 mm	25	0,732
1702560000	56x25x3 mm	25	0,588
1702580000	58x32x3 mm	25	0,760
1702590000	59x18x3 mm	25	0,760
170260X240	60x24,5x3 mm	25	0,788
1702630000	63x23x3 mm	25	0,880
170263X320	63x32x3 mm	25	0,828
1702800000	80x23x3 mm	25	1,160
1702900000	90x23x3 mm	25	1,504

Guarnizione cassetta tipo "K"

Grey para rubber gasket for cistern "K" type

cod.	misura	pz. x conf.	euro cad.
1702KA0000	58,5x18,5x3 mm	25	0,464



Guarnizione fondo "K" ultimo tipo

"K" bottom gasket last type

cod.	misura	pz. x conf.	euro cad.
1702KANT00	61x22	25	0,744



Guarnizione fondo tipo "I"

"I" type bottom gasket

cod.	misura	pz. x conf.	euro cad.
1702006029	60x29	25	0,712
1702044175	44x17,5	25	0,652



Guarnizione cappello in gomma nera per pulsante scarico tipo "I"

Black rubber cup gasket for "I" type cistern button

cod.	misura	pz. x conf.	euro cad.
17020030MM	30 mm	25	0,536



Imbuto para

Para rubber hopper

cod.	pz. x conf.	euro cad.
1107000000	25	0,880



Imbuto para doppio

Double para rubber hopper

cod.	pz. x conf.	euro cad.
1108000000	25	1,980



Morsetti in gomma nera

Black rubber joint

cod.	misura	pz. x conf.	euro cad.
1055252600	46x25/26	50	0,880



cod.	misura	pz. x conf.	euro cad.
1056300000	46x30	50	0,820



cod.	misura	pz. x conf.	euro cad.
1057263200	46x26/32	50	0,360



cod.	misura	pz. x conf.	euro cad.
1059320000	46x32	50	0,644
1059350000	46x35	50	0,692



cod.	misura	pz. x conf.	euro cad.
1060000000	46x40	50	0,264



cod.	misura	pz. x conf.	euro cad.
1076110000	110x90	25	1,256
1076120000	120x90	25	2,068
1076125900	125x90	25	3,736
1076611BISO	100/110x90	25	1,328



cod.	misura	pz. x conf.	euro cad.
1076/A0000	125x100	25	3,736



cod.	misura	pz. x conf.	euro cad.
1061260000	50x26	50	1,324
1061263500	50x26/35	50	0,968
1061303200	50x30/32	50	0,908
1061400000	50x40	50	0,420



cod.	misura	pz. x conf.	euro cad.
1064532632	53x26/32	50	0,976



cod.	misura	pz. x conf.	euro cad.
1064534000	53x40	50	0,688



cod.	misura	pz. x conf.	euro cad.
1061NIC032	50x25/32	50	0,648
1061NIC040	50x40	50	0,596



cod.	misura	pz. x conf.	euro cad.
1702NIC321	32x16	50	0,356
1702NIC322	32x22	50	0,356
1702NIC401	40x16	50	0,408
1702NIC402	40x22	50	0,408



cod.	misura	pz. x conf.	euro cad.
1061/A0000	50x25/40	50	1,800



cod.	misura	pz. x conf.	euro cad.
1060AL5040	55x40	50	0,596



cod.	misura	pz. x conf.	euro cad.
1062252600	32x25/26	50	0,352



cod.	misura	pz. x conf.	euro cad.
1062303200	40x26/30/32	50	0,332



cod.	misura	pz. x conf.	euro cad.
1062323540	50x32/35/40	50	0,648



cod.	misura	pz. x conf.	euro cad.
1062402526	40x25/26	50	0,480



cod.	misura	pz. x conf.	euro cad.
1062403032	40x30/32	50	0,456



cod.	misura	pz. x conf.	euro cad.
1062502600	50x25/26	50	0,736



cod.	misura	pz. x conf.	euro cad.
1062502632	50x26/32	50	0,484



cod.	misura	pz. x conf.	euro cad.
1063402526	40x25/26	50	0,596
1063502526	50x25/26	50	1,016
1063303235	50x30/32/35	50	0,868

Morsetti per scarico condensa
Joint for condensate drainage



cod.	misura	pz. x conf.	euro cad.
1066321826	32x18/26 interno	50	0,352
106634X14B	34x14 interno	50	1,496
106636X14G	36x14 interno	50	1,452

Morsetti in gomma bianca per wc

White rubber universal joint for wc



cod.	misura	pz. x conf.	euro cad.
106626BIAN	50x26	50	0,980
106630BIAN	50x30	50	0,360
106630PBIA	50x26/32	50	0,544



cod.	misura	pz. x conf.	euro cad.
106826BIAN	55x26	50	1,108
106830BIAN	55x30	50	0,820



cod.	misura	pz. x conf.	euro cad.
107026BIAN	60x26	50	1,412
107030BIAN	60x30	50	0,440
107044BIAN	60x26/44	50	0,952
107030PBIA	60x30 pesante	50	0,796



cod.	misura	pz. x conf.	euro cad.
1066/NT000	50x26/30	50	0,924



cod.	misura	pz. x conf.	euro cad.
1068/NT000	55x26/30	50	0,924



cod.	misura	pz. x conf.	euro cad.
1070/NT000	60x26/30	50	1,016



cod.	misura	pz. x conf.	euro cad.
1067404500	55x40/45	50	0,692



cod.	misura	pz. x conf.	euro cad.
1069404500	60x40/45	50	0,968



cod.	misura	pz. x conf.	euro cad.
107150BIAN	70x50	25	3,520



cod.	misura	pz. x conf.	euro cad.
107230BIAN	76x30	25	2,728
107240BIAN	76x40	25	2,596
107245BIAN	76x45	25	2,596
107250BIAN	76x50	25	2,244



Membrana in para nera alimentare per vasi ad espansione da 24 lt

Black para-rubber membrane for expansion tank of 24 lt

cod.	misura	pz. x conf.	euro cad.
7000000000	Ø flangia 90	30	4,896
7000000080	Ø flangia 80	30	4,896



Foglio esente amianto "fasit" 1500x1500 mm

"Fasit" asbestos free plate of 1500x1500 mm

cod.	misura	pz. x conf.	euro lastra
1084ESEQ02	sp. 2 mm	1	149,248
1084ESEQ03	sp. 3 mm	1	193,768



Foglio esente amianto "omnia" 1500x1500 mm

"Omnia" asbestos free plate of 1500x1500 mm

cod.	misura	pz. x conf.	euro lastra
1085ESEQ02	sp. 2 mm	1	334,112
1085ESEQ03	sp. 3 mm	1	501,168

**Foglio cartone
termoisolante 1000x1000 mm**
Thermoinsulating cardboard 1000x1000 mm



cod.	misura	pz. x conf.	euro lastra
1494ESE0005	sp. 5 mm	1	34,528
1494ESE0010	sp. 10 mm	1	69,056

Rotolo in gomma tela
Friction rubber roll



cod.	misura	pz. x conf.	euro kg
10851.5000	sp. 1,5 mm	58 kg ca. 1 rotolo	9,456
1085200000	sp. 2 mm	60 kg ca. 1 rotolo	7,124
10852.5000	sp. 2,5 mm	68 kg ca. 1 rotolo	7,124
1085300000	sp. 3 mm	54 kg ca. 1 rotolo	6,656
1085400000	sp. 4 mm	80 kg ca. 1 rotolo	6,656
1085500000	sp. 5 mm	98,5 kg ca. 1 rotolo	6,656

Scatola o'ring media
Medium box for o'ring



cod.	pz. x conf.	euro cad.
1097M00000	1	8,640

**Guarnizione per
tappo saltarello**
Gasket for plug ratchet



cod.	misura	pz. x conf.	euro cad.
1101000028	28x3 mm	100	0,164
1101000029	29x3 mm	100	0,164
1101000030	30x3 mm	100	0,168
1101000033	33x3 mm	100	0,192
1101000034	34x3 mm	100	0,200
11010031.5	31,5x3 mm	100	0,176

**Anello o'ring
per canne lavello**



O' ring for sink spouts

cod.	misura	pz. x conf.	euro cad.
OR8-----	8,9x2,7	100	0,060
OR9-----	10,5x2,7	100	0,064
OR112-----	9,92x2,62	100	0,036
OR3050/116	12,37x2,62	100	0,040
OR10-----	12,1x2,7	100	0,072

Anelli o'ring
O'ring

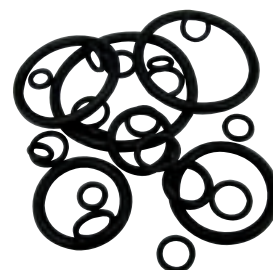

cod.	misura	pz. x conf.	euro cad.
OR1-----	2,6x1,9	100	0,044
OR2-----	3,4x1,9	100	0,044
OR3-----	4,2x1,9	100	0,044
OR4-----	4,9x1,9	100	0,044
OR5-----	5,7x1,9	100	0,044
OR5/A-----	6,4x1,9	100	0,044
OR6-----	7,2x1,9	100	0,048
OR6/A-----	8x1,9	100	0,048
OR7-----	8,9x1,9	100	0,048
OR8-----	8,9x2,7	100	0,060
OR9-----	10,5x2,7	100	0,064
OR10-----	12,1x2,7	100	0,072
OR11-----	13,6x2,7	100	0,084
OR12-----	15,1x2,7	100	0,092
OR13-----	16,9x2,7	100	0,104
OR14-----	18,4x2,7	100	0,112
OR15-----	18,3x3,6	100	0,176
OR16-----	19,8x3,6	100	0,188
OR17-----	21,3x3,6	100	0,200
OR18-----	23x3,6	100	0,212
OR19-----	24,6x3,6	100	0,212
OR20-----	26,2x3,6	100	0,244
OR21-----	27,8x3,6	100	0,236
OR22-----	29,3x3,6	100	0,248
OR23-----	30,8x3,6	100	0,248
OR24-----	32,5x3,6	100	0,260
OR25-----	34,1x3,6	100	0,284
OR26-----	35,6x3,6	100	0,288
OR27-----	37,3x3,6	100	0,308

ACCESSORI VARI E FISSAGGI

ACCESSORIES AND FIXING

Tappo in gomma bianca con catena

White rubber
plug with chain



cod.	misura	pz. x conf.	euro cad.
1102BC0027	27 mm	25	1,652
1102BC0031	31 mm	25	1,672
1102BC0040	40 mm	25	1,632
1102BC0044	44 mm	25	1,720
1102BC0047	47 mm	25	1,732
1102BC0052	52 mm	25	1,688
1102BC0057	57 mm	25	1,732

Tappo in gomma nera con catena

Black rubber plug
with chain



cod.	misura	pz. x conf.	euro cad.
1102NC0027	27 mm	25	1,576
1102NC0031	31 mm	25	1,592
1102NC0040	40 mm	25	1,552
1102NC0044	44 mm	25	1,592
1102NC0047	47 mm	25	1,596
1102NC0052	52 mm	25	1,552
1102NC0057	57 mm	25	1,596

Tappo in gomma bianca con rosetta inox

White rubber plug
with stainless rosette



cod.	misura	pz. x conf.	euro cad.
1103BC0027	27 mm	25	1,760
1103BC0031	31 mm	25	1,760
1103BC0040	40 mm	25	1,760
1103BC0044	44 mm	25	1,912
1103BC0047	47 mm	25	1,952
1103BC0052	52 mm	25	1,936
1103BC0057	57 mm	25	1,980

Tappo in gomma nera con rosetta inox

Black rubber plug
with stainless rosette



cod.	misura	pz. x conf.	euro cad.
1103NRC027	27 mm	25	1,688
1103NRC031	31 mm	25	1,700
1103NRC040	40 mm	25	1,696
1103NRC044	44 mm	25	1,776
1103NRC047	47 mm	25	1,816
1103NRC052	52 mm	25	1,808
1103NRC057	57 mm	25	1,848

Tappo bianco con maniglia

White plug with handle



cod.	misura	pz. x conf.	euro cad.
1102MIDB31	31 mm	25	0,564
1102MIDB40	40 mm	25	0,620
1102MIDB52	52 mm	25	0,696

Tappo nero con maniglia

Black plug with handle



cod.	misura	pz. x conf.	euro cad.
1102MIDN31	31 mm	50	0,564
1102MIDN40	40 mm	50	0,624
1102MIDN52	52 mm	50	0,700

Tappo in gomma nera con maniglia rosetta inox

Black rubber plug with handle
and stainless rosette



cod.	misura	pz. x conf.	euro cad.
1102NTLC52	52 mm	50	1,040

Tappo in gomma nera con nottolino e anello

Black rubber plug with ring and pawl



cod.	misura	pz. x conf.	euro cad.
1104N00027	27 mm	50	0,372
1104N00031	31 mm	50	0,396
1104N00040	40 mm	50	0,456
1104N00044	44 mm	50	0,497
1104N00047	47 mm	50	0,516
1104N00052	52 mm	50	0,552
1104N00057	57 mm	50	0,588

Pull bianca catena

White pull with chain



cod.	misura	pz. x conf.	euro cad.
1105BC0070	70 mm	25	2,264
1105BC0080	80 mm	25	2,432
1105BC0100	100 mm	25	2,820
1105BC0120	120 mm	25	3,200
1105BC0150	150 mm	25	3,680

Rullino portacarta in plastica bianco

White plastic roll for paper



cod.	pz. x conf.	euro cad.
1110B00000	10	0,360

Griglietta in polietilene neutro

Neutral polyethylene grid



cod.		pz. x conf.	euro cad.
1310NYLAVA	per lavabo	50	0,280
1310NYVASC	per vasca	50	0,280
1310NYLAVE	per lavello	50	0,280

Griglietta per lavelli

Grid for sinks



cod.		pz. x conf.	euro cad.
1310000000	acciaio inox	50	0,520

Griglietta a cestello inox per lavelli

Stainless basket-grid for sinks

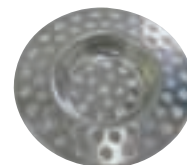

cod.	misura	pz. x conf.	euro cad.
1310NT0000	Ø 70	10	0,848
1310NT0080	Ø 80	10	0,960

Griglia cestello in zama cromata

Chromed zinc alloy basket-grid



cod.		pz. x conf.	euro cad.
131100000L	per lavello	10	2,652
131100000V	per vasca	10	2,440

Tappo copripiletta in ottone cromato

Brass chromed plated plug for drain pipe cover



cod.	misura	pz. x conf.	euro cad.
600800000G	1"	10	11,920
600800000GB	1"1/4	10	11,920
600800000GD	1"1/2	10	14,600

Tappo saltarello inox

Stainless ratchet plug

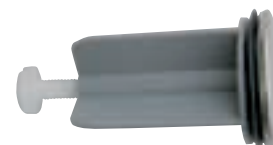

cod.	misura	pz. x conf.	euro cad.
6009PL00GB	1"1/4	10	3,040
6009PL000G	1"	10	2,800

Tappo saltarello cromato

Chromed plated complete ratchet plug



cod.	misura	pz. x conf.	euro cad.
600900000GB	38	10	5,000
600900000G	35	10	4,800

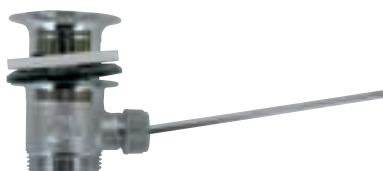

Scarico automatico in ottone

Automatic discharge drain valve
in nickel plated brass

cod.	misura	pz. x conf.	euro cad.
TP0000TTG	1"	10	10,320
TP0000TTGB	1"1/4	10	11,840

Piletta di scarico "ECO"

Drain valve "ECO"

cod.	misura	pz. x conf.	euro cad.
P10PIL000G	1"	10	10,000
P10PIL0000	1"1/4	10	11,200



Saltarello serie "Prince"

Ratchet "Prince" serie

cod.	pz. x conf.	euro cad.
P10SALT000	10	1,000



Kit asta per saltarello

Ratchet rod kit

cod.	pz. x conf.	euro cad.
TPAST00000	10	3,880



Fissaggio per monofori a 2 viti

Fixing-kit for double-hole faucets

cod.	pz. x conf.	euro cad.
TPFIX00000	10	0,800



Fissaggio per monofori a 1 vite

Fixing-kit for single-hole faucets

cod.	pz. x conf.	euro cad.
TPFIX10000	10	0,720



Deviatore per canna livello 3/4" x 1/2" x 3/4"

Deviator for lever sink spout 3/4" x 1/2" x 3/4"

cod.	pz. x conf.	euro cad.
PDV0000000	10	6,000



Canna livello in ottone cromato ad "S" con attacco universale, calotta F 3/4"

Universal attachment chromed plated brass
sink spout, with aerator cap F 3/4"

cod.	misura	pz. x conf.	euro cad.
1267R00200	18x200 mm	10	9,200
1267R00250	18x250 mm	10	9,200
1267R00300	18x300 mm	10	10,222



Canna livello in ottone cromato ad "U" con attacco universale, calotta F 3/4"

Universal attachment turned chrome plated brass
sink spout, with aerator, cap F 3/4"

cod.	misura	pz. x conf.	euro cad.
1267NTR200	18x200 mm	10	9,200
1267NTR250	18x250 mm	10	10,000
1267NTR300	18x300 mm	10	9,467



Canna livello in ottone cromato a "JOTA" con attacco universale, calotta F 3/4"

Universal attachment chrome plated brass
sink spout for one hole sink thread cap F 3/4"

cod.	misura	pz. x conf.	euro cad.
1268000000	18x200 mm	10	9,400



Ghiera cromata per troppo pieno per lavabo/bidet

Chromed ring nut for over flow for wash basin and
bidet

cod.	misura	pz. x conf.	euro cad.
700I13CROM	Ø 13 mm	10	0,372
700I19CROM	Ø 19 mm	10	0,372
700I24CROM	Ø 24 mm	10	0,372
700I28CROM	Ø 28 mm	10	0,396



Aeratore in ottone cromato

Chrome plated brass

cod.	misura	pz. x conf.	euro cad.
1313OTT000	M 24x1	10	0,640
1314OTT000	F 22x1	10	0,640
1317VOTT00	M 28x1 vasca	10	1,040



Aeratore perlator "LL"

"LL" perlator aerator

cod.	misura	pz. x conf.	euro cad.
1313PERLLL	M 24x1	10	1,088
1314PERLLL	F 22x1	10	1,088
1317PERLLL	M 28x1 vasca	5	2,000

Aeratore perlator "LL" a risparmio energetico

"LL" perlator aerator energy saving

cod.	misura	pz. x conf.	euro cad.
1313PERLLR	M 24x1	10	1,128
1314PERLLR	F 22x1	10	1,128
1317PERLLR	M 28x1 vasca	5	2,000

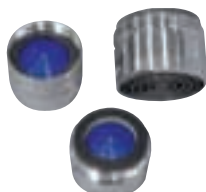

Aeratore in ottone cromato "Cascade"

Chrome plated brass aerator "Cascade"

cod.	misura	pz. x conf.	euro cad.
1313NEOCAS	M 24x1	10	2,168
1314NEOCAS	F 22x1	10	2,168
1317NEOCAS	M 28x1 vasca	5	4,760

Aeratore in ottone cromato "Cascade" a risparmio energetico

Chrome plated brass aerator "Cascade" energy saving

cod.	misura	pz. x conf.	euro cad.
1313NEOCAR	M 24x1	10	2,288
1314NEOCAR	F 22x1	10	2,288
1317NEOCAR	M 28x1 vasca	5	4,760



Aeratore in ottone cromato con snodo

Chrome plated brass aerator with ball joint

cod.	misura	pz. x conf.	euro cad.
1315000000	M 24x1	10	3,588
1316000000	F 22x1	10	3,588



Aeratore regolabile con snodo, a 2 funzioni

Adjustable aerator with ball joint, aerated or shower jet F

cod.	misura	pz. x conf.	euro cad.
1708000000	22x1	10	2,400



Aeratore prolungato bianco a 2 funzioni

Extended white aerator two jets

cod.	pz. x conf.	euro cad.
1700NT0000	10	3,200



Aeratore prolungato nero cromato a 2 funzioni

Extended chromed black aerator two jets

cod.	pz. x conf.	euro cad.
1701NT00CR	10	3,600



Eccentrico in ottone cromato con rosone

Chrome plated brass coupler with sliding flange

cod.	misura	pz. x conf.	euro cad.
12640000CF	M3/8"xM3/4"	10	4,360
12640000DF	M1/2"xM3/4"	10	2,200

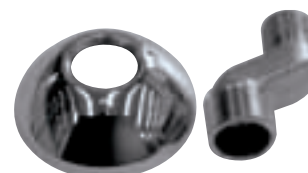

Eccentrico cromato con rosone, spost. 25mm

Chrome plated brass coupler "lux type" with sliding light flange, off set 25 mm

cod.	misura	pz. x conf.	euro cad.
1266NT000D	M1/2"xM3/4"	10	7,600

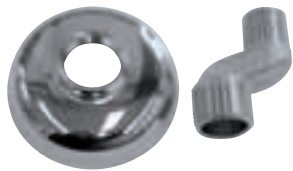

Eccentrico in ottone cromato tipo lusso con rosone pesante, spost. 25 mm

Chrome plated brass coupler "lux type" with flange, off set 25 mm

cod.	misura	pz. x conf.	euro cad.
1266NTP00D	M1/2"xM3/4"	10	11,200



Distanziatore in ottone cromato con rosone
Chrome plated brass connection with flange

cod.	misura	pz. x conf.	euro cad.
12650000D4	M1/2"xM3/4" spostamento 40 mm	10	6,680
12650000D6	M1/2"xM3/4" spostamento 60 mm	10	6,800
12650000D8	M1/2"xM3/4" spostamento 80 mm	10	8,560
12650000D10	M1/2"xM3/4" spostamento 100 mm	10	12,040



Serie 4 viti con tassello e boccola in nylon
4 screws serie with block and nylon bushing

cod.	serie	x conf.	euro cad.
1131E00000	in ottone	25	3,000
1131EF0000	in acciaio trp.80mm	25	1,200
1131EF0090	in acciaio trop.90mm	25	1,334
1131A00000	in acciaio	25	2,960

Viti zincate per fissaggio lavabo

Galvanized iron bolts for wash basin fixing

cod.	misura	cp. x conf.	euro cp.
1125000000	10x120	50	1,200



Viti zincate per fissaggio lavabo

Galvanized iron bolts for wash basin fixing

cod.	misura	cp. x conf.	euro cp.
1126000000	10x140 mm	50	1,422
1126000180	10x180 mm	25	2,711



Viti zincate per fissaggio scaldabagno

Galvanized ironed bolts for fixing water heater

cod.	misura	cp. x conf.	euro cp.
1127000075	10x75 mm	50	1,044
1127000095	10x95 mm	50	1,111



Viti zincate per fissaggio cassetta

Galvanized ironed bolts for cistern fixing

cod.	misura	cp. x conf.	euro cp.
1128000000	8x100 mm	50	0,876



Zanche in plastica a "L" antiurto con viti

Shock proof plastic zanche "L" with screws

cod.	cp. x conf.	euro cp.
1114PL0000	25	3,092



Mensole cromate per lavandino
Zinc alloy chromed brackets for sink

cod.	cp. x conf.	euro cp.
1212F00000	10	3,924



Mensole per lavello
Brackets for sink

cod.	pz. x conf.	euro cad.
1214000000	50	11,660



Mensole verniciate nuovo tipo per fissaggi lavabi

New model varnished bracket for wash basin fixing

cod.	misura	cp. x conf.	euro cp.
1214NT0034	340 mm	1	14,760
1214NT0046	460 mm	1	16,680

**Coppia supporti wc
in pvc con bulloni in ferro zincato**

Pvc couple supports for wc
with galvanized iron bolts



cod.	cp. x conf.	euro cp.
112100000	25	0,708

**Coppia supporti wc
con bulloni in pvc**

Couple supports for wc with pvc bolts



cod.	cp. x conf.	euro cp.
112200000	25	0,548

Coppia cerniere universali cromate per wc
Universal chromed couple supports for wc

cod.	cp. x conf.	euro cp.
1456H0000	25	6,588



**Kit di fissaggio
cerniere wc**

Fixing kit of supports for WC

cod.	cp. x conf.	euro cp.
1456/ACC00	25	0,456



**Collare fermatubo
in plastica**

Plastic collar for pipes

cod.	misura	pz. x conf.	euro cad.
1206000010	10 mm	100	0,182
1206000012	12 mm	100	0,200
1206000014	14 mm	100	0,231
1206000016	16 mm	100	0,249
1206000018	18 mm	100	0,316
1206000020	20 mm	100	0,356
1206000022	22 mm	50	0,373
1206000024	24 mm	50	0,529
1206000028	28 mm	50	0,796



**Collare fermatubo
in plastica tipo doppio**

Plastic collar double type for pipes

cod.	misura	pz. x conf.	euro cad.
1206D00010	10 mm	100	0,347
1206D00012	12 mm	100	0,369
1206D00014	14 mm	100	0,396
1206D00016	16 mm	100	0,404
1206D00018	18 mm	100	0,529
1206D00020	20 mm	100	0,564
1206D00022	22 mm	50	0,596
1206D00028	28 mm	50	1,018



**Collare di riparazione
a un tirante**

Collar one bayler stay

cod.	misura	pz. x conf.	euro cad.
1203TDB00D	21-25 da 1/2"	10	10,140
1203TDB00F	26-30 da 3/4"	10	10,140
1203TDB00G	33-37 da 1"	10	10,400
1203TDB0GB	42-45 da 1"1/4	10	10,660
1203TDB0GD	48-51 da 1"1/2	10	11,180
1203TDB00H	60-64 da 2"	10	15,080
1203TDB00I	87-93 da 3"	10	16,120



Collare fermatubo con tassello

Collar for pipes with block

cod.	misura	pz. x conf.	euro cad.
120500000C	3/8"	100	0,796
120500000D	1/2"	100	0,832
120500000F	3/4"	100	0,872
120500000G	1"	100	0,892
120500000GB	1"1/4	100	0,972
120500000GD	1"1/2	100	1,020
120500000H	2"	50	1,108
120500000HD	2"1/2	50	2,440
120500000I	3"	25	2,560
120500000L	4"	25	2,800



Collare leggero tropicalizzato con vite e tassello

Tropicalized light collar with screw and block



cod.	misura	pz. x conf.	euro cad.
1205LEG010	10 mm	100	0,436
1205LEG012	12 mm	100	0,444
1205LEG014	14 mm	100	0,452
1205LEG016	16 mm	100	0,464
1205LEG018	18 mm	100	0,468
1205LEG020	20 mm	100	0,476
1205LEG022	22 mm	100	0,480

Collari in rame

Copper collars

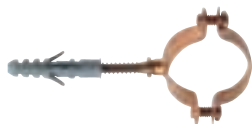

cod.	misura	pz. x conf.	euro cad.
1205RAME10	10 mm	100	1,568
1205RAME12	12 mm	100	1,596
1205RAME14	14 mm	100	1,644
1205RAME16	15/16 mm	100	1,696
1205RAME18	18 mm	100	1,724
1205RAME22	22 mm	100	1,776

Collare tubo fumo

Collar for smoke pipe



cod.	misura	pz. x conf.	euro cad.
504000080A	80/140 inox	25	5,112
504000080B	80/140 bianco	25	3,636
504000140A	140/200 inox	20	5,168
504000140B	140/200 bianco	20	4,104



Fascetta stringitubo

Hose clamp for tube

cod.	misura	pz. x conf.	euro cad.
1388000711	7-11 mm	200	0,860
1388001016	10-16 mm	200	0,536
1388001220	12-22 mm	200	0,576
1388001625	16-28 mm	200	0,584
1388002032	20-32 mm	200	0,620
1388002540	25-45 mm	100	0,728
1388003250	32-52 mm	100	0,812
1388004767	47-67 mm	100	0,856
1388007898	77-97 mm	50	0,928



Tappi e riduzioni in ferro zincato per radiatore

Galvanized iron plugs and reductions for radiator

cod.	misura	pz. x conf.	euro cad.
1170FZ0003	dx 48 1"	100	0,776
1170FZ0004	sx 48 1"	100	0,776
15140000GB	dx 48 1"x1/4"	100	0,776
1514SX00GB	sx 48 1"x1/4"	100	0,776
15140000GC	dx 48 1"x3/8"	100	0,776
1514SX00GC	sx 48 1"x3/8"	100	0,776
15140000GD	dx 48 1"x1/2"	100	0,776
1514SX00GD	sx 48 1"x1/2"	100	0,776
15140000GF	dx 48 1"x3/4"	100	1,012
1514SX00GF	sx 48 1"x3/4"	100	1,012



Tappi e riduzioni verniciate per radiatore

Varnished plug and reductions for radiator

cod.	misura	pz. x conf.	euro cad.
1170FVE001	dx 42 1"	100	0,920
1170FVE002	sx 42 1"	100	0,920
15180000GB	dx 42 1"x1/4"	100	0,920
1518SX00GB	sx 42 1"x1/4"	100	0,920
15180000GC	dx 42 1"x3/8"	100	0,920
1518SX00GC	sx 42 1"x3/8"	100	0,920
15180000GD	dx 42 1"x1/2"	100	0,920
1518SX00GD	sx 42 1"x1/2"	100	0,920
15180000GF	dx 42 1"x3/4"	100	1,156
1518SX00GF	sx 42 1"x3/4"	100	1,156
1170FVE003	dx 48 1"	100	0,920
1170FVE004	sx 48 1"	100	0,920
15200000GB	dx 48 1"x1/4"	100	0,920
1520SX00GB	sx 48 1"x1/4"	100	0,920
15200000GC	dx 48 1"x3/8"	100	0,920
1520SX00GC	sx 48 1"x3/8"	100	0,920
15200000GD	dx 48 1"x1/2"	100	0,920
1520SX00GD	sx 48 1"x1/2"	100	0,920
15200000GF	dx 48 1"x3/4"	100	1,156
1520SX00GF	sx 48 1"x3/4"	100	1,156
1170FVE005	dx 56 1"1/4	100	3,076
1170FVE006	sx 56 1"1/4	100	3,076
15230000GBB	dx 56 1"1/4x1/4"	100	3,076
1523SX00GBB	sx 56 1"1/4x1/4"	100	3,076
15230000GBC	dx 56 1"1/4x3/8"	100	3,076
1523SX00GBC	sx 56 1"1/4x3/8"	100	3,076
15230000GBD	dx 56 1"1/4x1/2"	100	3,076
1523SX00GBD	sx 56 1"1/4x1/2"	100	3,076
15230000GBF	dx 56 1"1/4x3/4"	100	3,476
1523SX00GBF	sx 56 1"1/4x3/4"	100	3,476



Tappi e riduzioni verniciate per radiatore con guarnizione

Varnished plug and reductions for radiator with gasket

cod.	misura	pz. x conf.	euro cad.
1170FVEGM1	dx 42 1"	100	1,084
1170FVEGM2	sx 42 1"	100	1,084
1518GM00GB	dx 42 1"x1/4"	100	1,084
1518GMSXGB	sx 42 1"x1/4"	100	1,084
1518GM00GC	dx 42 1"x3/8"	100	1,084
1518GMSXGC	sx 42 1"x3/8"	100	1,084
1518GM00GD	dx 42 1"x1/2"	100	1,084
1518GMSXGD	sx 42 1"x1/2"	100	1,084
1518GM00GF	dx 42 1"x3/4"	100	1,320
1518GMSXGF	sx 42 1"x3/4"	100	1,320

Valvolina sfiato per radiatore con guarnizione teflon

Breather drain for radiator with teflon gasket

cod.	misura	pz. x conf.	euro cad.
1194NTT00B	1/4"	100	1,792
1194NTT00C	3/8"	100	1,888
1194NTT00D	1/2"	100	2,192

Valvolina sfiato per radiatore orientabile

Breather drain for swinging radiator

cod.	misura	pz. x conf.	euro cad.
151000000C	3/8"	100	1,912
151000000D	1/2"	100	2,332

Tappo per riduzioni radiatore

Chrome plated plug for radiator

cod.	misura	pz. x conf.	euro cad.
1510TAP00C	3/8"	25	0,920
1510TAP00D	1/2"	25	1,000

Blister ridotto flangia 42 con tappo e valvola

Blister reduction flange 42 with plug and drain

cod.	misura	pz. x conf.	euro cad.
1523BLISTGC	1"x3/8"	25	7,800
1523BLISTGD	1"x1/2"	25	7,800



Mensola zincata per radiatore flangia 1"

Galvanized bracket for radiator flange 1"

cod.	misura	pz. x conf.	euro cad.
1207000019	19 cm	100	0,932
1207000023	23 cm	100	1,184
1207000026	26 cm	100	1,316
1207000029	29 cm	100	1,492

Mensola zincata con tassello per radiatore ghisa e acciaio

Galvanized bracket with small block for stainless and cast iron radiator

cod.	misura	cp. x conf.	euro cp.
1209G000020	20 cm	25	4,480
1209G000023	23 cm	25	4,736

Mensola verniciata per tubolari Ø 53

Varnished bracket for tubing Ø 53

cod.	misura	cp. x conf.	euro cp.
120953AC20	20 cm	25	2,732
120953AC22	22 cm	25	3,020

Mensola verniciata per tubolari Ø 60

Varnished bracket for tubing Ø 60

cod.	misura	cp. x conf.	euro cp.
120960AC20	20 cm	25	2,596
120960AC22	22 cm	25	2,864

Mensola smaltata per radiatore alluminio

Enameled bracket for aluminium radiator

cod.	misura	cp. x conf.	euro cp.
1209SM00000	17 cm	50	1,596

Mensola smaltata schiacciata per radiatore in alluminio

Enameled smashed bracket for aluminium radiator

cod.	misura	cp. x conf.	euro cp.
1209SMNT00	17 cm	50	1,660



Raccordo eccentrico in ottone sbiancato terminale MF 3/8"x3/8"

White brass excentric connector MF 3/8"x3/8"

cod.	misura	pz. x conf.	euro cad.
1265SPCC10	10 mm	10	5,376
1265SPCC20	20 mm	10	8,192
1265SPCC30	30 mm	10	8,448
1265SPCC40	40 mm	10	8,832
1265SPCC50	50 mm	10	10,240
1265SPCC60	60 mm	10	10,880

Raccordo eccentrico in ottone sbiancato terminale MF 1/2"x1/2"

White brass excentric connector MF 1/2"x1/2"

cod.	misura	pz. x conf.	euro cad.
1265SPDD10	10 mm	10	5,376
1265SPDD20	20 mm	10	8,192
1265SPDD30	30 mm	10	8,448
1265SPDD40	40 mm	10	8,832
1265SPDD50	50 mm	10	10,240
1265SPDD60	60 mm	10	10,880



Resistenza scaldabagno diritta

Straight water heater resistance

cod.	misura	pz. x conf.	euro cad.
14080W120I	1200 w	5	14,840
14080W1200	1200 w "ECO"	5	8,400



Resistenza scaldabagno curva

Bended water heater resistance

cod.	misura	pz. x conf.	euro cad.
1408CW120I	1200 w	5	15,280
1408CW1200	1200 w "ECO"	5	8,400



Resistenza scaldabagno diritta attacco flangia

Straight resistance for water heater with flange connection

cod.	misura	pz. x conf.	euro cad.
14090W120I	1200 w	5	13,800
14090W1200	1200 w "ECO"	5	7,600



Resistenza scaldabagno diritta con Faston prolungata

Straight resistance for water heater with extended flange

cod.	misura	pz. x conf.	euro cad.
1409WFP12I	1200 w	5	16,536
1409WFP12	1200 w "ECO"	5	7,600



Resistenza scaldabagno curva attacco a brugola

Bended resistance for water heater with head screw

cod.	misura	pz. x conf.	euro cad.
1409CW120I	1200 w	5	14,840
1409CW1200	1200 w "ECO"	5	8,400



Termostato per resistenza scaldabagno

Thermostat for radiator resistance

cod.		pz. x conf.	euro cad.
1410S0000I		5	7,840
1410S00000	"ECO"	5	5,600



Guarnizione in gomma per resistenza scaldabagno

Rubber gasket for water heater resistance

cod.	misura	pz. x conf.	euro cad.
1406000000	42x35,5x4 mm	100	0,172
1405000000	53x42x4 mm	100	0,200



Valvola sicurezza per scaldabagno MF

Security drain plug for water heater MF

cod.	misura	pz. x conf.	euro cad.
141100000D	1/2"	10	3,800



Valvola sicurezza per scaldabagno con leva MF

Security drain plug for water heater with lever MF

cod.	misura	pz. x conf.	euro cad.
1412000MFD	1/2"	10	4,760
1412000MFF	3/4"	10	10,584



Valvola per scaldabagno MF

Drain plug for water heater MF

cod.	misura	pz. x conf.	euro cad.
1412TE0000	1/2"	10	8,800

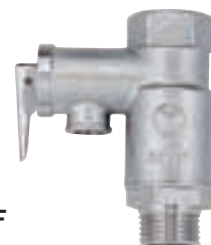

Valvola sicurezza con riduttore di pressione MF

Security drain plug with pressure reducer MF

cod.	misura	pz. x conf.	euro cad.
1412RP0MFD	1/2"	10	32,800



Valvola sicurezza ottone cromato "Plurima" MF

Chromed plated brass security drain plug "Plurima" MF

cod.	misura	pz. x conf.	euro cad.
1412PLU000	1/2"	10	13,500



Manometri 10 bar

Manometer 10 bar

cod.		pz. x conf.	euro cad.
14000RIZ00	attacco orizzontale	10	5,600



cod.		pz. x conf.	euro cad.
1400VERT00	attacco verticale	10	5,600



Prolunga in ottone nudo

Yellow brass extension

cod.	misura	pz. x conf.	euro cad.
11570I0C10	3/8"x10 mm	10	1,386
11570I0C15	3/8"x15 mm	10	1,683
11570I0C20	3/8"x20 mm	10	2,046
11570I0C25	3/8"x25 mm	10	2,182
11570I0C30	3/8"x30 mm	10	2,614
11570I0C40	3/8"x40 mm	10	2,955
11570I0C50	3/8"x50 mm	10	3,637
11570I0D10	1/2"x10 mm	10	1,749
11570I0D15	1/2"x15 mm	10	2,116
11570I0D20	1/2"x20 mm	10	2,501
11570I0D25	1/2"x25 mm	10	2,728
11570I0D30	1/2"x30 mm	10	3,183
11570I0D40	1/2"x40 mm	10	4,206
11570I0D50	1/2"x50 mm	10	5,115
11570I0D100	1/2"x100 mm	10	11,821
11570I0F10	3/4"x10 mm	10	2,273
11570I0F15	3/4"x15 mm	10	2,728
11570I0F20	3/4"x20 mm	10	3,183
11570I0F25	3/4"x25 mm	10	3,637
11570I0F30	3/4"x30 mm	10	4,092
11570I0F40	3/4"x40 mm	10	5,229
11570I0F50	3/4"x50 mm	10	6,138
11570I0G10	1"x10 mm	10	4,092
11570I0G15	1"x15 mm	10	4,774
11570I0G20	1"x20 mm	10	5,456
11570I0G25	1"x25 mm	10	6,138
11570I0G30	1"x30 mm	10	7,047
11570I0G40	1"x40 mm	10	8,184
11570I0G50	1"x50 mm	10	9,775



Prolunga in ottone cromato

Chrome plated brass extension

cod.	misura	pz. x conf.	euro cad.
11570CIC10	3/8"x10 mm	10	1,591
11570CIC15	3/8"x15 mm	10	1,863
11570CIC20	3/8"x20 mm	10	2,387
11570CIC25	3/8"x25 mm	10	2,614
11570CIC30	3/8"x30 mm	10	2,955
11570CIC40	3/8"x40 mm	10	3,410
11570CIC50	3/8"x50 mm	10	4,092
11570CID10	1/2"x10 mm	10	1,819
11570CID15	1/2"x15 mm	10	2,387
11570CID20	1/2"x20 mm	10	2,842
11570CID25	1/2"x25 mm	10	3,183
11570CID30	1/2"x30 mm	10	3,637
11570CID40	1/2"x40 mm	10	4,774
11570CID50	1/2"x50 mm	10	5,683
11570CID100	1/2"x100 mm	10	13,185
11570CIF10	3/4"x10 mm	10	2,728
11570CIF15	3/4"x15 mm	10	3,183
11570CIF20	3/4"x20 mm	10	3,637
11570CIF25	3/4"x25 mm	10	4,319
11570CIF30	3/4"x30 mm	10	4,774
11570CIF40	3/4"x40 mm	10	6,138
11570CIF50	3/4"x50 mm	10	7,047
11570CIG10	1"x10 mm	10	4,547
11570CIG15	1"x15 mm	10	5,229
11570CIG20	1"x20 mm	10	5,911
11570CIG25	1"x25 mm	10	6,820
11570CIG30	1"x30 mm	10	7,957



Prolunga ridotta filetto in ottone nudo

Reduced round threaded yellow brass extension

cod.	misura	pz. x conf.	euro cad.
11580I00BC	1/4"x3/8"	10	1,067
11580I00BD	1/4"x1/2"	10	1,547
11580I00CD	3/8"x1/2"	10	1,067
11580I00CF	3/8"x3/4"	10	2,204
11580I00DF	1/2"x3/4"	10	1,364
11580I00DG	1/2"x1"	10	3,069
11580I00FG	3/4"x1"	10	3,139
11580I0DGB	1/2"x1"1/4	10	3,421
11580I0FGB	3/4"x1"1/4	10	4,888
11580I0GGB	1"x1"1/4	10	4,774



Prolunga ridotta filetto in ottone cromato

Reduced round threaded chrome plated extension

cod.	misura	pz. x conf.	euro cad.
11580CI0BC	1/4"x3/8"	10	1,364
11580CI0BD	1/4"x1/2"	10	1,841
11580CI0CD	3/8"x1/2"	10	2,387
11580CI0CF	3/8"x3/4"	10	2,955
11580CI0DF	1/2"x3/4"	10	2,728
11580CI0DG	1/2"x1"	10	3,410
11580CI0FG	3/4"x1"	10	3,524



Riduzione esagonale doppio filetto in ottone nudo

Hexagonal double thread yellow brass reduction

cod.	misura	pz. x conf.	euro cad.
11630I00DB	1/2"x1/4"	10	0,906
11630I00CD	1/2"x3/8"	10	1,067
11630I00FC	3/4"x3/8"	10	2,204
11630I00DF	3/4"x1/2"	10	1,364
11630I00GC	1"x3/8"	10	3,637
11630I00GD	1"x1/2"	10	3,139
11630I00FG	1"x3/4"	10	2,614
11630I0GBD	1"1/4x1/2"	10	6,365
11630I0GBF	1"1/4x3/4"	10	5,456
11630I0GBG	1"1/4x1"	10	2,743
11630I0GDF	1"1/2x3/4"	10	4,910
11630I0GDG	1"1/2x1"	10	6,820
11630I0GDB	1"1/2x1"1/4	10	2,772



Riduzione esagonale doppio filetto in ottone cromato

Hexagonal double thread chrome plated brass reduction

cod.	misura	pz. x conf.	euro cad.
11630CI0CD	1/2"x3/8"	10	1,228
11630CI0FC	3/4"x3/8"	10	2,387
11630CI0DF	3/4"x1/2"	10	1,522
11630CI0GC	1"x3/8"	10	3,978
11630CI0GD	1"x1/2"	10	3,410
11630CI0FG	1"x3/4"	10	2,955



Nipples doppio filetto in ottone nudo

Double thread yellow brass nipple

cod.	misura	pz. x conf.	euro cad.
11610I00CC	3/8"x3/8"	10	1,159
11610I00DD	1/2"x1/2"	10	1,434
11610I00FF	3/4"x3/4"	10	2,046
11610I00GG	1"x1"	10	3,318
11610I0GBB	1"1/4x1"1/4	10	5,683
11610I0GDG	1"1/2x1"1/2	10	6,820
11610I00HH	2"x2"	10	11,275



Nipples ridotto doppio filetto in ottone nudo

Reduced double thread yellow brass nipple

cod.	misura	pz. x conf.	euro cad.
11610I00CB	3/8"x1/4"	10	1,181
11610I00DB	1/2"x1/4"	10	1,456
11610I00CD	1/2"x3/8"	10	1,456
11610I00FC	3/4"x3/8"	10	2,728
11610I00DF	3/4"x1/2"	10	2,138
11610I00GD	1"x1/2"	10	3,340
11610I00FG	1"x3/4"	10	3,410
11610I0GBF	1"1/4x3/4"	10	5,342
11610I0GBG	1"1/4x1"	10	5,342
11610I0GDF	1"1/2x3/4"	10	7,502
11610I0GDG	1"1/2x1"	10	6,934
11610I0GDB	1"1/2x1"1/4	10	7,275

Nipples ridotto doppio filetto in ottone cromato

Reduced double thread chrome plated brass nipple

cod.	misura	pz. x conf.	euro cad.
11610CI0CB	3/8"x1/4"	10	1,364
11610CI0DB	1/2"x1/4"	10	1,613
11610CI0CD	1/2"x3/8"	10	1,613
11610CI0FC	3/4"x3/8"	10	2,955
11610CI0DF	3/4"x1/2"	10	2,409
11610CI0GD	1"x1/2"	10	3,637
11610CI0FG	1"x3/4"	10	3,751



Nipples doppio filetto in ottone cromato

Double thread chrome plated brass nipple

cod.	misura	pz. x conf.	euro cad.
11610CI0CC	3/8"x3/8"	10	1,342
11610CI0DD	1/2"x1/2"	10	1,591
11610CI0FF	3/4"x3/4"	10	2,204
11610CI0GG	1"x1"	10	3,593



Tappo femmina in ottone nudo

Yellow brass female plug

cod.	misura	pz. x conf.	euro cad.
11680I000C	3/8"	10	0,953
11680I000D	1/2"	10	1,001
11680I000F	3/4"	10	1,547
11680I000G	1"	10	2,182
11680I00GB	1"1/4	10	3,546



Tappo femmina in ottone cromato

Chrome plated brass female plug

cod.	misura	pz. x conf.	euro cad.
11680CI00C	3/8"	10	1,093
11680CI00D	1/2"	10	1,228
11680CI00F	3/4"	10	1,863
11680CI00G	1"	10	2,728



Tappo maschio in ottone nudo

Yellow brass male plug

cod.	misura	pz. x conf.	euro cad.
11660I000C	3/8"	10	0,979
11660I000D	1/2"	10	1,067
11660I000F	3/4"	10	1,672
11660I000G	1"	10	2,728
11660I00GB	1"1/4	10	4,228

Tappo maschio in ottone cromato

Chrome plated brass male plug

cod.	misura	pz. x conf.	euro cad.
11660CI00C	3/8"	10	1,115
11660CI00D	1/2"	10	1,228
11660CI00F	3/4"	10	1,910
11660CI00G	1"	10	3,025

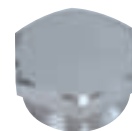

Nipples tutto filettato in ottone nudo

Yellow brass all threaded nipple

cod.	misura	pz. x conf.	euro cad.
116200000C	3/8"	10	1,932
116200000D	1/2"	10	2,204
116200000F	3/4"	10	2,955
116200000G	1"	10	3,865



Ghiera in ottone nudo doppio filetto

Yellow brass double thread ring nut

cod.	misura	pz. x conf.	euro cad.
11640000CD	3/8"x1/2"	10	0,704
11640000DF	1/2"x3/4"	10	0,887
11640000FG	3/4"x1"	10	1,408
1164000GGB	1"x1"1/4	10	2,273
116400GBGD	1"1/4x1"1/2	10	2,501



Gomito in ottone nudo MF

Yellow brass MF elbow

cod.	misura	pz. x conf.	euro cad.
11960I000C	3/8"	10	3,593
11960I000D	1/2"	10	2,955
11960I000F	3/4"	10	4,888
11960I000G	1"	10	7,275
11960I00GB	1"1/4	10	12,049
11960I00GD	1"1/2	10	16,823



Gomito in ottone cromato MF

Chrome plated brass MF elbow

cod.	misura	pz. x conf.	euro cad.
11960CI00C	3/8"	10	3,593
11960CI00D	1/2"	10	3,707
11960CI00F	3/4"	10	5,456
11960CI00G	1"	10	8,866



Gomito in ottone in nudo FF

Yellow brass FF elbow



cod.	misura	pz. x conf.	euro cad.
11970I000C	3/8"	10	2,842
11970I000D	1/2"	10	3,340
11970I000F	3/4"	10	4,319
11970I000G	1"	10	7,887
11970I000GB	1" 1/4	10	12,503
11970I000GD	1" 1/2	10	17,959

Gomito in ottone cromato FF

Chrome plated brass FF elbow



cod.	misura	pz. x conf.	euro cad.
11970CI00C	3/8"	10	3,637
11970CI00D	1/2"	10	4,250
11970CI00F	3/4"	10	5,342
11970CI00G	1"	10	9,321

Tee in ottone nudo FFF

Yellow brass FFF T-piece



cod.	misura	pz. x conf.	euro cad.
11980I000C	3/8"	10	3,524
11980I000D	1/2"	10	3,524
11980I000F	3/4"	10	4,547
11980I000G	1"	10	8,639
11980I000GB	1" 1/4	10	14,777
11980I000GD	1" 1/2	1	21,824
11980I000H	2"	1	29,553

Tee in ottone cromato FFF

Chrome plated brass FFF T-piece



cod.	misura	pz. x conf.	euro cad.
11980CI00C	3/8"	10	4,433
11980CI00D	1/2"	10	4,206
11980CI00F	3/4"	10	5,456
11980CI00G	1"	10	10,230

Manicotto femmina in ottone nudo

Yellow brass female sleeve



cod.	misura	pz. x conf.	euro cad.
11990I000C	3/8"	10	1,477
11990I000D	1/2"	10	2,090
11990I000F	3/4"	10	2,772
11990I000G	1"	10	4,888
11990I000GB	1" 1/4	10	5,911
11990I000GD	1" 1/2	10	3,183
11990I000H	2"	1	15,913

Manicotto femmina in ottone cromato

Chrome plated brass female sleeve



cod.	misura	pz. x conf.	euro cad.
11990CI00C	3/8"	10	1,661
11990CI00D	1/2"	10	2,501
11990CI00F	3/4"	10	3,252
11990CI00G	1"	10	5,229

Manicotto ridotto FF in ottone nudo

Yellow brass reduced FF sleeve



cod.	misura	pz. x conf.	euro cad.
11990I00DC	1/2"x3/8"	10	1,863
11990I00FD	3/4"x1/2"	10	2,842
11990I00GD	1"x1/2"	10	3,905
11990I00GF	1"x3/4"	10	3,524
11990I00GBF	1" 1/4x3/4"	10	7,957
11990I00GBG	1" 1/4x1"	10	6,593
11990IGDGB	1" 1/2x1" 1/4	1	11,821
11990IOHGD	2"x1" 1/2	1	20,460

Manicotto ridotto FF in ottone cromato

Chrome plated brass reduced FF sleeve

cod.	misura	pz. x conf.	euro cad.
11990CIOFD	3/4"x1/2"	10	3,296
11990CIOGD	1"x1/2"	10	3,637
11990CIOGF	1"x3/4"	10	3,909
11990CIGBF	1" 1/4x3/4"	10	8,411
11990CIGBG	1" 1/4x1"	10	7,047

Barilotti in ottone

Brass tanks



cod.	misura	pz. x conf.	euro cad.
11740TD50	1/2"x50 mm	10	2,728
11740TD80	1/2"x80 mm	10	4,092
11740TD100	1/2"x100 mm	10	4,774
11740TD120	1/2" 120 mm	10	6,365
11740TD150	1/2"x150 mm	10	6,219
11740TDF50	3/4"x50 mm	10	3,637
11740TDF80	3/4"x80 mm	10	5,001
11740TF100	3/4"x100 mm	10	5,911
11740TF150	3/4"x150 mm	10	8,639
11740TOG50	1"x50 mm	10	4,774
11740TOG80	1"x80 mm	10	7,047
11740TG100	1"x100 mm	10	8,411
11740TG150	1"x150 mm	10	13,185

Bocchettoni in ottone nudo MF

Yellow brass MF union pipe



cod.	misura	pz. x conf.	euro cad.
12010000D	1/2"	10	5,229
12010000F	3/4"	10	7,047
12010000G	1"	10	11,708
12010000GB	1"1/4	10	21,597
12010000GD	1"1/2	1	28,644
12010000H	2"	1	54,652

cod.	misura	pz. x conf.	euro cad.
12010CCG0D	1/2"	10	7,275
12010CCG0F	3/4"	10	9,662
12010CCG0G	1"	10	15,686
12010CCG0B	1"1/4	10	14,190
12010CCG0D	1"1/2	1	35,237
12010CCG0H	2"	1	102,300

Prolunga in ottone nudo "ECO"

"ECO" yellow brass extension



cod.	misura	pz. x conf.	euro cad.
1157000C10	3/8"x10 mm	10	0,692
1157000C15	3/8"x15 mm	10	0,860
1157000C20	3/8"x20 mm	10	1,028
1157000C25	3/8"x25 mm	10	1,168
1157000C30	3/8"x30 mm	10	1,368



Prolunga in ottone nudo "ECO"

"ECO" yellow brass extension

cod.	misura	pz. x conf.	euro cad.
1157000C40	3/8"x40 mm	10	1,766
1157000C50	3/8"x50 mm	10	2,170
1157000D10	1/2"x10 mm	10	0,892
1157000D15	1/2"x15 mm	10	1,064
1157000D20	1/2"x20 mm	10	1,261
1157000D25	1/2"x25 mm	10	1,472
1157000D30	1/2"x30 mm	10	1,828
1157000D40	1/2"x40 mm	10	2,149
1157000D50	1/2"x50 mm	10	2,928
1157000F10	3/4"x10 mm	10	1,288
1157000F15	3/4"x15 mm	10	1,472
1157000F20	3/4"x20 mm	10	1,860
1157000F25	3/4"x25 mm	10	2,212
1157000F30	3/4"x30 mm	10	2,912
1157000F40	3/4"x40 mm	10	3,532
1157000F50	3/4"x50 mm	10	4,293



Prolunga in ottone cromato "ECO"

"ECO" chrome plated brass extension

cod.	misura	pz. x conf.	euro cad.
11570C0C10	3/8"x10 mm	10	0,756
11570C0C15	3/8"x15 mm	10	0,924
11570C0C20	3/8"x20 mm	10	1,096
11570C0C25	3/8"x25 mm	10	1,256
11570C0C30	3/8"x30 mm	10	1,448
11570C0C40	3/8"x40 mm	10	1,812
11570C0C50	3/8"x50 mm	10	2,224
11570C0D10	1/2"x10 mm	10	0,912
11570C0D15	1/2"x15 mm	10	1,081
11570C0D20	1/2"x20 mm	10	1,303
11570C0D25	1/2"x25 mm	10	1,528
11570C0D30	1/2"x30 mm	10	1,916
11570C0D40	1/2"x40 mm	10	2,224
11570C0D50	1/2"x50 mm	10	3,056
11570C0F10	3/4"x10 mm	10	1,324
11570C0F15	3/4"x15 mm	10	1,544
11570C0F20	3/4"x20 mm	10	1,948
11570C0F25	3/4"x25 mm	10	2,283
11570C0F30	3/4"x30 mm	10	3,008
11570C0F40	3/4"x40 mm	10	3,633
11570C0F50	3/4"x50 mm	10	4,428

**Prolunga ridotta filetto
in ottone nudo "ECO"**



"ECO" yellow brass reduced extension

cod.	misura	pz. x conf.	euro cad.
11580000CD	3/8"x1/2"	10	0,841
11580000DF	1/2"x3/4"	10	1,320

**Prolunga ridotta filetto
in ottone cromato "ECO"**



"ECO" chrome plated brass reduced extension

cod.	misura	pz. x conf.	euro cad.
11580C00CD	3/8"x1/2"	10	0,939
11580C00DF	1/2"x3/4"	10	1,364

**Riduzione esagonale
doppio filetto in ottone nudo "ECO"**



"ECO" yellow brass double thread

hexagonal reduction

cod.	misura	pz. x conf.	euro cad.
11630000CD	1/2"x3/8"	10	0,580
11630000DF	3/4"x1/2"	10	0,980

**Riduzione esagonale
doppio filetto in ottone cromato "ECO"**



"ECO" chrome plated brass double thread

hexagonal reduction

cod.	misura	pz. x conf.	euro cad.
11630C00CD	1/2"x3/8"	10	0,644
11630C00DF	3/4"x1/2"	10	1,048

**Nipples doppio filetto
in ottone nudo "ECO"**



"ECO" yellow brass double thread nipple

cod.	misura	pz. x conf.	euro cad.
11610000CC	3/8"x3/8"	10	0,696
11610000CD	3/8"x1/2"	10	0,872
11610000DD	1/2"x1/2"	10	0,944
11610000DF	1/2"x3/4"	10	1,552
11610000FF	3/4"x3/4"	10	1,648

**Nipples doppio filetto
in ottone cromato "ECO"**



"ECO" chrome plated brass double thread nipple

cod.	misura	pz. x conf.	euro cad.
11610C00CC	3/8"x3/8"	10	0,756
11610C00CD	3/8"x1/2"	10	0,940
11610C00DD	1/2"x1/2"	10	1,020
11610C00DF	1/2"x3/4"	10	1,656
11610C00FF	3/4"x3/4"	10	1,752

**Gomito in ottone nudo
MF "ECO"**



"ECO" yellow brass MF elbow

cod.	misura	pz. x conf.	euro cad.
119600000C	3/8"	20	1,779
119600000D	1/2"	20	2,254
119600000F	3/4"	10	3,519

**Gomito in ottone cromato
MF "ECO"**



"ECO" chrome plated brass MF elbow

cod.	misura	pz. x conf.	euro cad.
11960C000C	3/8"	20	1,849
11960C000D	1/2"	20	2,338
11960C000F	3/4"	10	3,655

**Gomito in ottone nudo
FF "ECO"**



"ECO" yellow brass FF elbow

cod.	misura	pz. x conf.	euro cad.
119700000C	3/8"	20	1,741
119700000D	1/2"	20	2,325
119700000F	3/4"	10	3,124

**Gomito in ottone cromato
FF "ECO"**



"ECO" chrome plated brass FF elbow

cod.	misura	pz. x conf.	euro cad.
11970C000C	3/8"	20	1,804
11970C000D	1/2"	20	2,401
11970C000F	3/4"	10	3,238

**Tee in ottone nudo
FFF "ECO"**



"ECO" yellow brass FFF T-piece

cod.	misura	pz. x conf.	euro cad.
119800000C	3/8"	20	2,182
119800000D	1/2"	20	2,578
119800000F	3/4"	10	3,629

**Tee in ottone cromato
FFF "ECO"**



"ECO" chrome plated brass FFF T-piece

cod.	misura	pz. x conf.	euro cad.
11980C000C	3/8"	20	2,258
11980C000D	1/2"	20	2,675
11980C000F	3/4"	10	3,768

**Manicotto femmina
in ottone nudo "ECO"**



"ECO" yellow brass female sleeve

cod.	misura	pz. x conf.	euro cad.
119900000C	3/8"	20	1,020
119900000D	1/2"	20	1,116
119900000F	3/4"	10	1,811

**Manicotto femmina
in ottone cromato "ECO"**



"ECO" chrome plated brass female sleeve

cod.	misura	pz. x conf.	euro cad.
11990C000C	3/8"	20	1,104
11990C000D	1/2"	20	1,216
11990C000F	3/4"	10	2,015

**Tappo femmina
in ottone nudo "ECO"**



"ECO" Yellow brass female plug

cod.	misura	pz. x conf.	euro cad.
116800000C	3/8"	10	0,698
116800000D	1/2"	10	0,813
116800000F	3/4"	10	1,636
116800000G	1"	10	2,342

**Tappo femmina
in ottone cromato "ECO"**



"ECO" Chrome plated brass female plug

cod.	misura	pz. x conf.	euro cad.
11680C000C	3/8"	10	0,756
11680C000D	1/2"	10	0,867
11680C000F	3/4"	10	1,684
11680C000G	1"	10	2,458

**Tappo maschio
in ottone nudo "ECO"**



"ECO" Yellow brass male plug

cod.	misura	pz. x conf.	euro cad.
116600000C	3/8"	10	0,560
116600000D	1/2"	10	0,720
116600000F	3/4"	10	1,062
116600000G	1"	10	2,209

**Tappo maschio
in ottone cromato "ECO"**



"ECO" Chrome plated brass male plug

cod.	misura	pz. x conf.	euro cad.
11660C000C	3/8"	10	0,636
11660C000D	1/2"	10	0,796
11660C000F	3/4"	10	1,147
11660C000G	1"	10	2,320

**Riduzione in ottone
cromato MF**



Chrome plated brass MF reduction

cod.	misura	pz. x conf.	euro cad.
11690C0GGB	1"x1"1/4	10	3,244
11690CGBGD	1"1/4x1"1/2	10	4,400

**Tappo maschio in ottone nudo con rosone
inox**



Yellow brass male plug with stainless steel rosette

cod.	misura	pz. x conf.	euro cad.
116510000C	3/8"	10	2,332
116510000D	1/2"	10	2,432



Tappo maschio con rosone in ottone tipo lusso

Chrome plated brass male plug with rosette lux type

cod.	misura	pz. x conf.	euro cad.
1165L00000	1/2"	25	4,360
116500000D	1/2" senza rosone	25	3,760



Nipples in ottone cromato

Chrome plated brass nipple

cod.	misura	pz. x conf.	euro cad.
77800C0D10	1/2"x10	25	3,009



Nipples doppia ogiva in ottone cromato inserto 3 pz.

Chrome plated brass double nipple 3 pieces

cod.	misura	pz. x conf.	euro cad.
77810C3P10	10 mm	25	3,012
77810C3P12	12 mm	25	3,792
77810C3P14	14 mm	10	4,304



Nipples in ottone cromato

Chrome plated brass nipple

cod.	misura	pz. x conf.	euro cad.
1337000C10	3/8"x10	25	2,196
1337000D10	1/2"x10	25	2,532
77820C3P12	1/2"x12	25	2,688
77820C3P14	1/2"x14	10	2,484

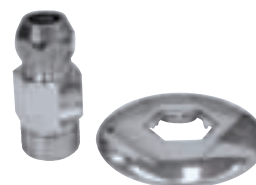

Nipples esagonale con rosone

Hexagonal nipple with rosette

cod.	misura	pz. x conf.	euro cad.
G025620000	1/2"x3/8"x10	25	3,373



Prolunga in ferro zincato

Galvanized ironed connection

cod.	misura	pz. x conf.	euro cad.
1181F00C10	3/8"x10	10	0,456
1181F00C15	3/8"x15	10	0,508
1181F00C20	3/8"x20	10	0,568
1181F00C25	3/8"x25	10	0,688
1181F00C30	3/8"x30	10	0,784
1181F00D10	1/2"x10	10	0,364
1181F00D15	1/2"x15	10	0,396
1181F00D20	1/2"x20	10	0,460
1181F00D25	1/2"x25	10	0,620
1181F00D30	1/2"x30	10	0,772
1181F00D40	1/2"x40	10	1,564
1181F00D50	1/2"x50	10	1,780
1181F00F10	3/4"x10	10	0,924
1181F00F15	3/4"x15	10	1,020
1181F00F20	3/4"x20	10	1,140
1181F00F25	3/4"x25	10	1,376
1181F00F30	3/4"x30	10	1,528
1181F00F40	3/4"x40	10	2,536
1181F00F50	3/4"x50	10	2,884
1181F00G10	1"x10	10	1,820
1181F00G15	1"x15	10	2,116
1181F00G20	1"x20	10	2,492
1181F00G30	1"x30	10	3,128



Riduzione MF in ferro zincato

Galvanized ironed threaded MF reduction

cod.	misura	pz. x conf.	euro cad.
1182F000AB	1/8"x1/4"	10	0,592
1182F000BC	1/4"x3/8"	10	0,656
1182F000BD	1/4"x1/2"	10	0,756
1182F000CD	3/8"x1/2"	10	0,484
1182F000CF	3/8"x3/4"	10	1,304
1182F000DF	1/2"x3/4"	10	1,132
1182F000DG	1/2"x1"	10	1,972
1182F000FG	3/4"x1"	10	1,788
1182F000GB	1"x1"1/4	10	5,384

Riduzione FF in ferro zincato

Galvanized ironed
threaded FF reduction



cod.	misura	pz. x conf.	euro cad.
1184F000AB	1/4"x1/8"	10	0,900
1184F000AC	3/8"x1/8"	10	0,988
1184F000BC	3/8"x1/4"	10	0,716
1184F000CD	1/2"x3/8"	10	0,756
1184F000DB	1/2"x1/4"	10	1,020
1184F000DF	3/4"x1/2"	10	1,184
1184F000FC	3/4"x3/8"	10	1,400
1184F000GD	1"x1/2"	10	2,364
1184F000GF	1"x3/4"	10	2,184
1184F00GBG	1"x1/4x1"	10	8,736

Nipples in ferro zincato

Galvanized ironed
double thread nipple



cod.	misura	pz. x conf.	euro cad.
1185F000AA	1/8"x1/8"	10	0,620
1185F000AB	1/4"x1/8"	10	0,456
1185F000BB	1/4"x1/4"	10	0,484
1185F000BC	3/8"x1/4"	10	0,532
1185F000CC	3/8"x3/8"	10	0,536
1185F000CD	1/2"x3/8"	10	0,688
1185F000CF	3/4"x3/8"	10	1,264
1185F000CG	1"x3/8"	10	1,988
1185F000DD	1/2"x1/2"	10	0,468
1185F000DF	3/4"x1/2"	10	1,140
1185F000DG	1"x1/2"	10	1,912
1185F000FF	3/4"x3/4"	10	1,028
1185F000FG	1"x3/4"	10	1,912
1185F000GG	1"x1"	10	2,024

Nipples tutto filetto in ferro zincato

Galvanized ironed threaded nipple



cod.	misura	pz. x conf.	euro cad.
1186F0000B	1/4"	10	0,796
1186F0000C	3/8"	10	0,552
1186F0000D	1/2"	10	0,688
1186F0000F	3/4"	10	1,048
1186F0000G	1"	10	1,528

Riduzione esagonale in ferro zincato

Galvanized ironed
double thread nuts



cod.	misura	pz. x conf.	euro cad.
1187F000AB	1/4"x1/8"	10	0,384
1187F000AC	3/8"x1/8"	10	0,628
1187F000AD	1/2"x1/8"	10	0,864
1187F000BC	3/8"x1/4"	10	0,416
1187F000BD	1/2"x1/4"	10	0,488
1187F000CD	1/2"x3/8"	10	0,472
1187F000CG	1"x3/8"	10	1,556
1187F000DF	3/4"x1/2"	10	0,868
1187F000FB	3/4"x1/4"	10	1,028
1187F000FC	3/4"x3/8"	10	0,972
1187F000FG	1"x3/4"	10	1,436
1187F000GD	1"x1/2"	10	1,472

Controdado esagonale in ferro zincato

Hexagonal galvanized ironed
lock-nut



cod.	misura	pz. x conf.	euro cad.
1188F0000A	1/8"	10	0,436
1188F0000B	1/4"	10	0,436
1188F0000C	3/8"	10	0,456
1188F0000D	1/2"	10	0,620
1188F0000F	3/4"	10	0,952
1188F0000G	1"	10	1,248

Dado femmina in ferro zincato

Galvanized ironed
female nut



cod.	misura	pz. x conf.	euro cad.
1189F0000A	1/8"	10	0,408
1189F0000B	1/4"	10	0,408
1189F0000C	3/8"	10	0,396
1189F0000D	1/2"	10	0,456
1189F0000F	3/4"	10	0,920
1189F0000G	1"	10	1,660

Tappo maschio in ferro zincato

Galvanized ironed plug



cod.	misura	pz. x conf.	euro cad.
1166F0000A	1/8"	10	0,428
1166F0000B	1/4"	10	0,328
1166F0000C	3/8"	10	0,396
1166F0000D	1/2"	10	0,364
1166F0000F	3/4"	10	0,896
1166F0000G	1"	10	1,460



Manicotto in ferro zincato

Galvanized iron sleeve

cod.	misura	pz. x conf.	euro cad.
1176F0000A	1/8"	10	0,692
1176F0000B	1/4"	10	0,704
1176F0000C	3/8"	10	0,672
1176F0000D	1/2"	10	0,824
1176F0000F	3/4"	10	1,012
1176F0000G	1"	10	1,452
1176F0000GB	1"1/4	10	2,156
1176F0000GD	1"1/2	10	2,716
1176F0000H	2"	10	3,740

Manicotto ridotto MF

Reduced MF sleeve

cod.	misura	pz. x conf.	euro cad.
1180BISFCD	1/2"x3/8"	10	0,948
1180BISDFD	3/4"x1/2"	10	1,364
1180BISFFG	1"x3/4"	10	2,276



Barilotto in ferro zincato

Galvanized ironed tank with double thread

cod.	misura	pz. x conf.	euro cad.
1174F00C80	3/8"x80 mm	10	1,608
1174F00C100	3/8"x100 mm	10	2,008
1174F00C150	3/8"x150 mm	10	2,712
1174F00C200	3/8"x200 mm	10	3,420
1174F00D80	1/2"x80 mm	10	0,920
1174F00D100	1/2"x100 mm	10	1,012
1174F00D150	1/2"x150 mm	10	1,272
1174F00D200	1/2"x200 mm	10	1,496
1174F00F80	3/4"x80 mm	10	1,040
1174F00F100	3/4"x100 mm	10	1,196
1174F00F150	3/4"x150 mm	10	1,588
1174F00F200	3/4"x200 mm	10	2,008
1174F00G80	1"x80 mm	10	1,464
1174F00G100	1"x100 mm	10	1,684
1174F00G150	1"x150 mm	10	2,092
1174F00G200	1"x200 mm	10	2,860



Tappo prova impianti in "PP" con o'ring da 1/2"

Testing plug in "PP" 1/2" with o'ring

cod.		pz. x conf.	euro cad.
1190NTB000	blu	50	0,277
1190NTR000	rosso	50	0,277
1190NTG000	giallo	50	0,277



Tappo prova impianti in nylon da 1/2" con o'ring

Testing plug in nylon 1/2" with o'ring

cod.		pz. x conf.	euro cad.
1190NTTA00	azzurro	50	0,451
1190NTTR00	rosso	50	0,451



Tappo prova impianti filetto in ottone 1/2" con o'ring

Testing plug with brass insert thread 1/2" and o'ring

cod.		pz. x conf.	euro cad.
11900TTB0D	blu	50	1,564
11900TTR0D	rosso	50	1,564

RACCORDI PER SCARICHI

FITTINGS FOR OUTLET PIPE



NIAGARA FLESS

Tubo estensibile per wc da 285 a 625mm

Extensible pipe for WC from 285 to 625 mm

cod.		pz. x conf.	euro cad.
3131SUPERO	con rinforzo acc.	25	6,400
3131NTT000	Monob PPL	15	7,333



NIAGARINO

Tubo estensibile comprimibile per wc

Extensible/compressible pipe for wc

cod.		pz. x conf.	euro cad.
3133000000	ECO	16	5,067



Tubo flessibile comprimibile per wc
lung. min 250 e max 400 mm

Flexible/compressible pipe
for wc min length 250 and max 400 mm

cod.		pz. x conf.	euro cad.
3131PR0000		15	6,512
3131PRABSO	Term. ABS	15	6,972



Tubo flessibile comprimibile
per wc lung. min 320 e max 540 mm

Flexible/compressible pipe
for wc min length 320 and max 540 mm

cod.		pz. x conf.	euro cad.
3132PR0000		15	7,224
3132PRABSO	Term. ABS	15	7,560



Tubo estensibile monoblocco per wc

Extensible pipe MONO-BLOCK for WC

cod.		pz. x conf.	euro cad.
3131MON000		16	4,889



Tubo rigido diritto per scarico wc
Wc rigid straight pipe

cod.	misure	pz. x conf.	euro cad.
3134000000	Ø 110 - L 400 mm	9	8,280
3134ROSONE		10	6,656

Tubo rigido diritto per scarico wc con rosone
Wc rigid straight pipe with rosette

cod.	misure	pz. x conf.	euro cad.
3134000100	Ø 100 - L 255 mm	12	9,152



Curva sottovaso
under wc bowl bend

cod.	pz. x conf.	euro cad.
3131CUR000	10	5,892



STARFLESS
Sistema di scarico universale estensibile con ghiera metallo

Extensible waste system with metal nut

cod.	misura	pz. x conf.	euro cad.
260246OG26	1"x26 mm	100	1,600
260246OOG	1"x32 mm	100	1,600
260246OGB	1"1/4x32 mm	100	1,600
260246OGBGD	1"1/4x32/40 mm	100	1,600
260246OOGD	1"1/2x40 mm	100	1,600
260246OGDGD	1"1/2x32/40 mm	100	1,600
260246OOD45	1"1/2x40/50 mm	100	1,600



STARFLESS
Sistema di scarico universale estensibile con ghiera plastica

Extensible universal waste system with plastic nut

cod.	misura	pz. x conf.	euro cad.
260246POG26	1"x26 mm	100	1,400
260246POOG	1"x32 mm	100	1,400
260246POGB	1"1/4x32 mm	100	1,400
260246PGB04	1"1/4x32/40 mm	100	1,400
260246POGD	1"1/2x40 mm	100	1,400
260246PGD04	1"1/2x32/40 mm	100	1,400
260246PGD5	1"1/2x40/50 mm	100	1,400



STARFLESS
Sistema di scarico universale estensibile a doppio imbuto

Extensible double socket universal waste system

cod.	misura	pz. x conf.	euro cad.
260246DI26	26x26 mm	100	1,360
260246DI32	32x32 mm	100	1,360
260246DI3240	32/40x32/40 mm	100	1,360
260246DI40	40x40 mm	25	1,360
260246DI4050	40/50x40/50 mm	25	1,360



STARFLESS
Sistema di scarico universale estensibile con prolunga per guarnizione conica

Universal waste system extensible with extension and conical gasket

cod.	misura	pz. x conf.	euro cad.
260246C0GB	1"1/4x32 mm	100	1,420
260246CGB04	1"1/4x32/40 mm	100	1,420
260246C0GD	1"1/2x40 mm	100	1,420
260246CGD04	1"1/2x32/40 mm	25	1,420
260246CGD5	1"1/2x40/50 mm	25	1,420



Rosone in PP per raccordi rapidi
PP Flange for flexible pipes

cod.	misura	pz. x conf.	euro cad.
1476ROS032	32 mm	50	0,096
1476ROS040	40 mm	50	0,096
1476ROS050	50 mm	50	0,096

Metallizzato
Metallized

cod.	misura	pz. x conf.	euro cad.
1476ROSC32	32 mm	50	0,680
1476ROSC40	40 mm	50	0,680
1476ROSC50	50 mm	50	0,680



SUPERSTARFLESS

Super raccordo rapido cromato con rosone

Super chromed rapid connection with rosette

cod.	misura	pz. x conf.	euro cad.
260246CRG26	1"x26 mm	100	5,000
260246CR0G	1"x32 mm	100	5,000
260246CRGB	1"1/4x32 mm	100	5,000
260246CRGBGD	1"1/4x32/40 mm	100	5,000
260246CRGD	1"1/2x40 mm	100	5,000
260246CRGDGD	1"1/2x32/40 mm	100	5,000
260246CRD45	1"1/2x40/50 mm	100	5,000

Altri colori su richiesta - Other colours on demand



SUPERSTARFLESS

Super raccordo rapido cromato a doppio imbuto

Super chromed rapid connection with double socket

cod.	misura	pz. x conf.	euro cad.
260246DC26	26x26 mm	100	4,800
260246DC32	32x32 mm	100	4,800
260246DC3240	32/40x32/40 mm	100	4,800
260246DC40	40x40 mm	100	4,800
260246DC4050	40/50x40/50 mm	100	4,800

Altri colori su richiesta - Other colours on demand



Scarico universale con doppio tubo flessibile

Universal waste system with double flexible pipe

cod.	misura	pz. x conf.	euro cad.
260246DU00	1"1/2 x 40/50	50	3,644



Kit scarico universale 2 vie attacco 1"1/2 uscita Ø 40 mm

Universal waste kit two ways attach 1"1/2 outlet Ø 40 mm

cod.	misura	pz. x conf.	euro cad.
2607KIT0GD	1"1/2 x 40	30	6,222
2608KIT0GD	con pilette 1"1/2	25	9,778



MONOBLOCCO con piletta PP bianco

UNIBLOCK with waste white PP

cod.	misura	pz. x conf.	euro cad.
260246PL32	Ø 65 uscita 32	100	2,440
260246PL3240	Ø 65 uscita 32/40	100	2,440
260246PL40	Ø 70 uscita 40	100	2,440
260246P73240	Ø 70 uscita 32/40	100	2,440
260246PL4050	Ø 70 uscita 40/50	100	2,440
260246PL45	Ø 80 uscita 40/50	100	4,800

Metallizzati su richiesta - Metallized on demand



Raccordo rapido ghiera a stringere

Rapid extensible with closing nut

cod.	misura	pz. x conf.	euro cad.
260246GSGB	F 1"1/2x1"1/4	100	3,000
260246GSGD	F 1"1/2x1"1/2	100	3,000



Raccordo rapido ghiera a stringere e imbuto

Rapid extensible with closing nut and socket

cod.	misura	pz. x conf.	euro cad.
260246GS32	F 1"1/2x32	100	3,200
260246GS40	F 1"1/2x40	100	3,200



Tubo spiralato in PVC atossico

PVC atoxic spiraled pipe

cod.	misura	mt. x conf.	euro cad.
1476ROT00G	Ø 32 mm	20	2,120
1476ROT0GD	Ø 40 mm	20	2,924



Imbuto in ABS per tubi spiralati

Hopper in ABS for spiraled pipes

cod.	misura	pz. x conf.	euro cad.
1476IMB00G	26 mm x tubo Ø 32	25	1,092
1476IMB0GB	32 mm x tubo Ø 32	25	1,040
1476IMBGGD	40 mm x tubo Ø 32	25	1,092
1476IMB4GB	32 mm x tubo Ø 40	25	1,176
1476IMB0GD	40 mm x tubo Ø 40	25	1,120
1476IMB050	50 mm x tubo Ø 40	25	1,176



Raccordo in ABS con ghiera cromata

ABS connection with chrome plated ring

cod.	misura	pz. x conf.	euro cad.
1476SR000G	1" x tubo Ø 32	50	2,856
1476SR00GB	1"1/4 x tubo Ø 32	50	3,192
1476SR400G	1" x tubo Ø 40	50	3,192
1476SR40GB	1"1/4 x tubo Ø 40	50	2,856
1476SR00GD	1"1/2 x tubo Ø 40	50	3,192



Raccordo in ABS con ghiera in plastica

ABS connection with plastic ring

cod.	misura	pz. x conf.	euro cad.
1476SRP00G	1" x tubo Ø 32	50	2,772
1476SRP0GB	1"1/4 x tubo Ø 32	50	2,436
1476SRP40G	1" x tubo Ø 40	50	2,640
1476SRP4GB	1"1/4 x tubo Ø 40	50	2,436
1476SRP0GD	1"1/2 x tubo Ø 40	50	2,640



Prolunga per wc

Wc extension

cod.	misura	pz. x conf.	euro cad.
1073ST0000	concentrica	24	1,360
1074ST0000	eccentrica	24	1,360



Prolunga maggiorata per wc

Wc oversized extension

cod.	misura	pz. x conf.	euro cad.
1073MG0000	concentrica	48	7,484
1074MG0000	eccentrica	48	7,484



Prolunga eccentrica per wc 4 cm

Wc excentric extension 4 cm

cod.	misura	pz. x conf.	euro cad.
5619420000		15	3,178



Prolunga in gomma nera per wc

Wc black rubber extension

cod.	misura	pz. x conf.	euro cad.
1075000000	concentrica	45	4,840
4005000000	eccentrica	20	6,600



Prolunga girevole per wc

Wc rotating extension

cod.	misura	pz. x conf.	euro cad.
1075GR0000		12	3,756



Protezione universale antiurto / acustica per vasi e bidet sospesi in materiale isofon

Isofon universal protection shock resistant - anti noise for suspended bidet and wc

cod.	misura	pz. x conf.	euro cad.
1455000000		10	9,120

COMPLEMENTI PER IMPIANTI IDRAULICI

ACCESSORIES FOR HYDRAULIC SYSTEMS

SIFONI IN OTTONE BRASS SIPHONS



Sifone bottiglia in ottone cromato senza piletta

Brass bottle trap for sink without drain valve

cod.	misura	pz. x conf.	euro cad.
22250C000G	1"	10	15,200
22250C00GB	1"1/4	10	17,600



Sifone "S" in ottone cromato con ispezione

Chrome plated brass "S" siphon with inspection

cod.	misura	pz. x conf.	euro cad.
22280C000G	1"	10	15,200
22280C00GB	1"1/4	10	17,600



Sifone a colonna in ottone cromato con ispezione

Chrome plated brass column siphon with inspection

cod.	misura	pz. x conf.	euro cad.
22280C000G	1"	10	15,200
22280C00GB	1"1/4	10	17,600



Sifone lusso in ottone lucido cromato per lavabi a vista

Bright chrome lux brass siphon for wash basin

cod.	misura	pz. x conf.	euro cad.
2228LUX1GB	1"1/4	1	61,440



Sifone lusso in ottone lucido cromato per lavabi a vista

Bright chrome lux brass siphon for wash basin

cod.	misura	pz. x conf.	euro cad.
2228LUX2GB	1"1/4	1	48,889



Sifone lusso in ottone lucido cromato per lavabi a vista

Bright chrome lux brass siphon for wash basin

cod.	misura	pz. x conf.	euro cad.
2228LUX3GB	1"1/4	1	49,778



Piletta automatica click-clack 1"1/4

Automatic drain valve click-clack 1"1/4

cod.		pz. x conf.	euro cad.
1464PUSH00	"Lusso"	1	22,222
1464PUSHTP	"Lusso"	1	22,222
	con troppo pieno		
1464PUSHX0	"Eco"	1	12,444
1464PUSXTP	"Eco"	1	12,444
	con troppo pieno		



Piletta automatica click-clack 1"1/4 tutto filetto in ottone cromato per lavabo e bidet

Automatic chrome brass drain valve for basin and bidet

cod.		pz. x conf.	euro cad.
1464PUSH10		1	21,333
1464PUSH1T	con troppo pieno	1	21,333



Piletta automatica click-clack 1"1/4 per ceramica e vetro

automatic click-clack drain valve 1"1/4 suitable for ceramic and glass

cod.		pz. x conf.	euro cad.
1464PUSHUN		1	17,778



Piletta automatica tappo quadro 1"1/4

Automatic drain valve with square plug 1"1/4

cod.		pz. x conf.	euro cad.
1464PULX00		1	22,222
1464PULXTP	con troppo pieno	1	22,222

SIFONI IN PLASTICA PLASTIC SIPHONS



Sifone in PP senza piletta con tubo Ø 40 mm

PP siphon without drain valve with pipe Ø 40 mm

cod.	misura	pz. x conf.	euro cad.
2230ES10GB	1"1/4	10	3,160
2230ES20GB	1"1/2	10	2,720
2230ES30GD	1"1/2 c/att.lavat.	10	2,800



Sifone 2 vie in PP senza piletta con tubo Ø 40 mm

PP two ways siphon without drain valve with pipe Ø 40 mm

cod.	misura	pz. x conf.	euro cad.
2230ES31GD	1"1/2	10	4,400
2230ES32GD	1"1/2 c/att.lavat.	10	4,560



Sifone tipo "SP" a una via in PP Ø 40 mm con attacco lavatrice

PP oneway "SP" siphon Ø 40 mm with washing machine connection

cod.	misura	pz. x conf.	euro cad.
2230ES40GD	1"1/2	10	3,600



Sifone tipo "SP" a due vie in PP Ø 40 mm con attacco lavatrice

PP two ways siphon Ø 40 mm with washing machine connection

cod.	misura	pz. x conf.	euro cad.
2230ES50GD	1"1/2	10	8,600



Sifone fiasco a una via senza piletta in PP

PP trap for sink at one way
without drain valve

cod.	misura	pz. x conf.	euro cad.
14660000GB	1" 1/4 canotto 32 mm	10	3,320
1466000LGB	1" 1/4 c/att.lav. canotto 32 mm	10	3,440
14660000GD	1" 1/2 canotto 40 mm	10	3,320
1466000LGD	1" 1/2 c/att.lav canotto 40 mm	10	3,440



Sifone fiasco a due vie senza piletta in PP

PP trap for sink at two ways
without drain valve

cod.	misura	pz. x conf.	euro cad.
14670000GB	1" 1/4 canotto 32 mm	10	5,280
1467000LGB	1" 1/4 c/att.lav. canotto 32 mm	10	5,360
14670000GD	1" 1/2 canotto 40 mm	10	5,280
1467000LGD	1" 1/2 c/att.lav. canotto 40 mm	10	5,360



Sifone BOTTIGLIA

Bottle Trap

cod.	misura	pz. x conf.	euro cad.
22250000GB	1" 1/4 canotto 32 mm	10	3,400
2225LAV0GB	1" 1/4 c/att.lav. canotto 32 mm	10	3,480
22250000GD	1" 1/2 canotto 40 mm	10	3,400
2225LAV0GD	1" 1/2 c/att.lav. canotto 40 mm	10	3,480



Sifone BOTTIGLIA a 2 vie

Two ways bottle trap

cod.	misura	pz. x conf.	euro cad.
22290000GB	1" 1/4 canotto 32 mm	10	5,280
2229LAV0GB	1" 1/4 c/att.lav. canotto 32 mm	10	5,360
22290000GD	1" 1/2 canotto 40 mm	10	5,280
2229LAV0GD	1" 1/2 c/att.lav. canotto 40 mm	10	5,360



Piletta gattinara

Drain valve gattinara

cod.	misura	pz. x conf.	euro cad.
1464PP00GB	1" 1/4 Ø 80	10	1,912
1464PP00GD	1" 1/2 Ø 80	10	1,912



Piletta livello inox

Drain valve for sink

cod.	misura	pz. x conf.	euro cad.
14640000GB	1" 1/4 Ø 65	10	2,000
14640070GD	1" 1/2 Ø 70	10	2,089



Piletta in ottone per lavello con tappo e catenella

Brass drain valve for sink with plug and chain

cod.	misura	pz. x conf.	euro cad.
14640T00GB	1" 1/4	10	5,333
14640T00GD	1" 1/2	10	7,556



**Pilettone lavello inox in PP
senza troppo pieno con tappo**

PP drain valve for inox sink
without overflow with plug

cod.	misura	pz. x conf.	euro cad.
1464PI00GD	1" 1/2	10	1,880



**Piletta lavello inox in PP per troppo pieno con
tappo**

PP drain valve for sink with overflow and plug

cod.	misura	pz. x conf.	euro cad.
1464PITPGD	1" 1/2	10	1,980
1464PILOGD	1" 1/2 c/att.lav.	10	2,500



**Piletta per lavelli in PP
bianca 90 mm, flangia
e cestello acciaio inox 18,8**

Drain valve for sink in white
PP material 90 mm, stainless
steel flange and frame 18,8

cod.	misura	pz. x conf.	euro cad.
2227CR0000	3" 1/2	100	4,880



**Piletta per lavelli in PP
bianca 90 mm, flangia e
cestello acciaio inox 18,8
con troppo pieno regolabile**

Drain valve for sink in white PP material 90 mm,
stainless steel flange and frame 18,8
with adjustable overflow

cod.	misura	pz. x conf.	euro cad.
3227CR0000	3" 1/2	10	5,760



Scarico troppo pieno

Overflow - waste

cod.	misura	pz. x conf.	euro cad.
1470RTPRET	tubo rigido scarico ret.63x39	10	1,240
1470FTPRET	tubo flessibile scarico ret.63x39	10	1,280
1470FTPROT	tubo flessibile scarico rot.d.40	10	2,080



Bacino per troppo pieno con scarico rotondo

Connection for overflow with rounded waste

cod.		pz. x conf.	euro cad.
1470BIANCO	bianco	10	3,000
14700CROMO	cromato	10	7,000



Riduzione PP bianca MxF

White PP reduction MxF

cod.	misura	pz. x conf.	euro cad.
1357000000	1" 1/4x1" 1/2	25	0,533



Riduzione PP bianca MxF

White PP reduction MxF

cod.	misura	pz. x conf.	euro cad.
1357NT0000	1" 1/2x1" 1/4	25	0,533



Riduzione PP bianca MxF

White PP reduction MxF

cod.	misura	pz. x conf.	euro cad.
6003000000	1"x1" 1/4	25	0,578

**Prolunga universale
in PP con attacco lavatrice**

Universal extension in PP material
with washing machine connection



cod.	misura	pz. x conf.	euro cad.
1464MCA0GB	1" 1/4	10	3,160
1464MCA0GD	1" 1/2	10	3,160

**Raccordo portagomma
lavatrice/lavastoviglie in PP bianco**

Double pipe fitting for washing
and dish machine in white PP



cod.	misura	pz. x conf.	euro cad.
1352AB0000	1"	10	0,520

**Raccordo portagomma
lavatrice/lavastoviglie cromato**

Chromed double fitting
for washing and disher machine



cod.	misura	pz. x conf.	euro cad.
1352ACR000	1"	10	1,800

**Raccordo attacco lavatrice/
lavastoviglie in PP bianco**

Chromed double fitting for washing and disher
machine



cod.	misura	pz. x conf.	euro cad.
1476CL00GD	1" 1/2	10	2,400



Scarico vasca 1" 1/2 con tubo estensibile
Bath discharge 1" 1/2 with extensible pipe

cod.		pz. x conf.	euro cad.
2610PLTEST	plastica c/tubo estensibile	10	4,000
2610PLTRIG	plastica c/tubo rigido	10	4,800
26100TTRIG	ottone c/tubo rigido	10	14,400

Colonna scarico in PVC automatica

Automatic PVC discharge pipe



cod.	misura	pz. x conf.	euro cad.
2610B00000	1" 1/2	10	10,222

**Colonna scarico automatica
per vasca in ottone**

Automatic discharge pipe for bath
in chrome plated brass



cod.		pz. x conf.	euro cad.
2610N00000		20	38,756

**Colonna scarico automatica click-click in
in ottone per vasca**

Automatic discharge pipe in click-click in
chrome plated brass for bath



cod.		pz. x conf.	euro cad.
2610CL0000		20	53,333

**Sifone per vasca in ottone
fuso con dado e codulo**

Brass melted siphon for bath tube with nut tang



cod.	misura	pz. x conf.	euro cad.
2610NS0000	1" 1/2	10	20,889

**Sifone in PVC 1" 1/2
scarico inclinato 40/50 mm**

PVC siphon 1" 1/2 with drain valve 40/50 mm



cod.		pz. x conf.	euro cad.
198RPI00GD	ghiera ottone	10	11,828



Sifone in PVC 1"1/2 scarico inclinato 40/50 mm

PVC siphon 1"1/2 with drain valve 40/50 mm

cod.		pz. x conf.	euro cad.
198RPP00GD	ghiera plastica	10	3,400



Sifone doccia orientabile in PEHD con piletta Ø 80

Swinging shower siphon in PEHD with drain Ø 80

cod.	misura	pz. x conf.	euro cad.
2610DOCC01	Ø 80x50-40	10	18,320



Scarico doccia 1"1/2 Ø 80

Shower tray waste 1"1/2 Ø 80

cod.		pz. x conf.	euro cad.
1464DOC0GD	ottone	10	4,400
1464DOCPGD	plastica	10	1,600



Sifone per piatto doccia con piletta in ottone

Siphon for shower-plate with brass drain valve

cod.	misura	pz. x conf.	euro cad.
2610DOCGRI	Ø 50 mm	10	8,000



Sifone per piatto doccia con piattello cromato

Siphon for shower-plate with chromed cap

cod.	misura	pz. x conf.	euro cad.
2610DOC090	Ø 90 mm	10	8,400
2610DOC060	Ø 60 mm	10	7,200
2610DOC050	Ø 50 mm	10	14,200



Scarico doccia sifonato in ottone con scarico 1"1/4 in ottone

Brass shower-plate waste with brass discharge 1"1/4

cod.	misura	pz. x conf.	euro cad.
2610DOT080	Ø 80 mm	10	20,000
2610DOT050	Ø 50 mm	10	14,800



Scarico esterno sifonato in PP con sfera, molla e rosone

External discharge siphon in PP material with ball joint, spring and rosette

cod .		pz. x conf.	euro cad.
1354NT0000		10	2,300



Scarico esterno sifonato in PP cromato con sfera, molla e rosone

External siphon drain connection in chrome plated PP with ball joint, spring and rosette

cod .		pz. x conf.	euro cad.
1354NTC000		10	6,100



Sifone incasso lavatrice mm 40

Embedding siphon for washing machine mm 40

cod.		pz. x conf.	euro cad.
1361NTOABS	placca bianca	10	3,000
1361NTINOX	placca inox	10	3,600



Sifone incasso lavatrice tipo "Lux" in PEHD
Embedding siphon for washing machine in PEHD

cod.	misura	pz. x conf.	euro cad.
1361NTLUX0	40/50 mm	10	10,320



Tubo carico lavatrice con raccordi in PVC, FF

Inlet pipe for washing machine with PVC connections, FF

cod.	misura	pz. x conf.	euro cad.
1341FFP100	3/4"x3/4" L 100 cm	10	1,973
1341FFP150	3/4"x3/4" L 150 cm	10	2,208
1341FFP200	3/4"x3/4" L 200 cm	10	2,693
1341FFP250	3/4"x3/4" L 250 cm	10	3,186
1341FFP300	3/4"x3/4" L 300 cm	10	3,803
1341FFP350	3/4"x3/4" L 350 cm	10	4,539
1341FFP400	3/4"x3/4" L 400 cm	10	4,962
1341FFP500	3/4"x3/4" L 500 cm	10	5,936



Tubo carico lavatrice con curva, raccordi in PVC, FF

Inlet pipe for washing machine with bend, PVC connections, FF

cod.	misura	pz. x conf.	euro cad.
1341CFP100	3/4"x3/4" L 100 cm	10	2,047
1341CFP150	3/4"x3/4" L 150 cm	10	2,290
1341CFP200	3/4"x3/4" L 200 cm	10	2,771
1341CFP250	3/4"x3/4" L 250 cm	10	3,260
1341CFP300	3/4"x3/4" L 300 cm	10	3,881
1341CFP350	3/4"x3/4" L 350 cm	10	4,617
1341CFP400	3/4"x3/4" L 400 cm	10	5,040
1341CFP500	3/4"x3/4" L 500 cm	10	6,006



Tubo carico lavatrice con curva, treccia metallica raccordi in ottone cromato, FF

Inlet pipe for washing machine with bend, metal plait, chromed plated brass connections, FF

cod.	misura	pz. x conf.	euro cad.
1345000150	3/4"x3/4" L 150 cm	10	17,228
1345000200	3/4"x3/4" L 200 cm	10	20,480



Tubo scarico lavatrice in materiale termoplastico con manicotti in gomma

Outlet pipe for washing machine in thermoplastic material with rubber connections

cod.	misura	pz. x conf.	euro cad.
1346000100	L 100 cm	10	1,125
1346000150	L 150 cm	10	1,215
1346000200	L 200 cm	10	1,530
1346000250	L 250 cm	10	1,845
1346000300	L 300 cm	10	2,160
1346000350	L 350 cm	10	2,475
1346000400	L 400 cm	10	2,835
1346000500	L 500 cm	10	3,510



**Supporto in materiale plastico
a 180° per tubo scarico lavatrice**

Support bend in plastic material 180°
for washing machine outlet pipe

cod.	pz. x conf.	euro cad.
1349000180	10	0,177



**Raccordo diritto per tubo scarico
lavatrice in materiale termoplastico**

Straight connection for washing machine
outlet pipe in thermoplastic material

cod.	misura	pz. x conf.	euro cad.
1348000000	Ø 19	20	0,653
1348000021	Ø 21	20	0,300



**Rotolo tubo scarico
lavatrice in materiale termoplastico**

Roll for washing machine outlet pipe
in thermoplastic material

cod.	mt x conf.	euro mt
1346ROT000	20	0,765



**Raccordo doppio in nylon
per lavatrice/lavastoviglie attacchi FxMxM**

Double nylon connection for washing
and dishing machine FxMxM

cod.	misura	pz. x conf.	euro cad.
1362000000	3/4"x3/4"x3/4"	10	1,900



**Raccordo curvo in nylon
per lavatrice/lavastoviglie attacchi MxF**

Double nylon connection for washing
and dishing machine MxF

cod.	misura	pz. x conf.	euro cad.
1362C00000	3/4"x3/4"	10	1,900



**Raccordo diritto tubo
scarico in materiale plastico**

Straight connection for outlet
pipe in plastic material

cod.	misura	pz. x conf.	euro cad.
1363019X19	19x19 mm	50	0,196
1363019X22	19x22 mm	50	0,196
1363022X22	22x22 mm	50	0,196



Raccordo triplo per lavatrice

Triple connection for washing machine

cod.	pz. x conf.	euro cad.
13633VIE00	50	0,956



**Nipples doppio filetto
in materiale plastico MxM**

Double thread nipple in plastic material MxM

cod.	misura	pz. x conf.	euro cad.
1364000000	3/4"x3/4"	50	0,204



**Tubo scarico "Wash-fless"
per lavatrice/lavastoviglie
estensibile/comprimibile**

Outlet pipe "Wash-fless" for washing
and dishing machine extensible/compressible

cod.	misura	pz. x conf.	euro cad.
1343NT0000	da 600 a 2000 mm	25	2,205
1343NT3000	da 900 a 3000 mm	25	2,430
1343NT4000	da 1200 a 4000 mm	25	3,160



**Tubo scarico "Wash-fless"
per lavatrice/lavastoviglie
estensibile/comprimibile con curva**

Outlet pipe "Wash-fless" for washing and dishing machine extensible/compressible

cod.	misura	pz. x conf.	euro cad.
1343NTC000	da 600 a 2000 mm	25	2,295
1343NTC300	da 900 a 3000 mm	25	2,520



**Tappo ad espansione
per pozzetto**

Expansion plug for water trap

cod.	misura	pz. x conf.	euro cad.
1299NT0080	80 mm	20	4,664
1299NT0090	90 mm	20	1,647
1299NT0100	100 mm	20	1,520
1299NT0120	120 mm	10	2,111



**Tappo ad espansione
per pozzetto con placca inox**

Expansion plug for water trap with stainless steel plate

cod.	misura	pz. x conf.	euro cad.
1299NTP090	90 mm	20	2,702
1299NTP100	100 mm	20	2,069
1299NTP120	120 mm	10	3,758



**Tappo ad espansione
a griglia con placca grigliata inox**

Grid expansion plug with stainless plate

cod.	misura	pz. x conf.	euro cad.
1300NTP090	90	10	6,572
1300NTP100	100	10	3,800
1300NTP120	120	10	10,960



Coperchio coprisifone in acciaio inox

Stainless steel cover for siphon

cod.	misura	pz. x conf.	euro cad.
1298I00130	130 mm	10	1,044
1298I00140	140 mm	10	1,200
1298I00150	150 mm	10	1,440

Vite per copripozzetto

Screw for trap-cover

cod.	misura	pz. x conf.	euro cad.
1298VITE00	6x30 mm	100	0,088



Pozzetto scarico pavimento

Floor trap

cod.	misura	pz. x conf.	euro cad.
1300GRI100	100x100 uscita Ø 40/50 mm	10	3,520
1300GRI150	150x150 uscita Ø 40/50/63 mm	10	4,800
1300GRI200	200x200 uscita Ø 63/75/80/82 mm	10	9,800
1300GRI250	250x250 uscita Ø 100/110 mm	10	13,600
1300GRI300	300x300 uscita Ø 100/110 mm	10	25,000



Pozzetto scarico pavimento con 4 uscite

Gully trap with 4 exits

cod.	misura	pz. x conf.	euro cad.
1300004VIE	Ø 100 mm	1	18,000



**Sifoni scarico pavimento 150x150 - uscita
Ø 50**

Floor drain traps 150x150 - exit Ø 50

cod.		pz. x conf.	euro cad.
130000ORIZ	orizzontale	10	15,000
130000VERT	verticale	10	15,000



Piletta per lavatoio in ottone nudo

Drain valve in yellow brass for sink

cod.	misura	pz. x conf.	euro cad.
12180000G	1"	10	18,360
12180000GB	1" 1/4	10	27,360
12180000GD	1" 1/2	4	46,080
12180000H	2"	4	63,936



Piletta cassone in ottone nudo con controdado e dado

Drain valve in yellow brass with backnut and nut

cod.	misura	pz. x conf.	euro cad.
12210000D	1/2"	20	6,568
12210000F	3/4"	15	8,720
12210000G	1"	10	10,672



Piletta cassone in ottone nudo filettata

Tank drain valve internal threaded

cod.	misura	pz. x conf.	euro cad.
1222FILODC	1/2"x3/8"	20	8,620
1222FILOFD	3/4"x1/2"	20	10,260
1222FILOGF	1"x3/4"	15	13,132
1222FILGBG	1" 1/4x1"	5	18,880



Piletta cassone in ottone nudo filettata con tappo

Tank drain valve internal threaded with plug

cod.	misura	pz. x conf.	euro cad.
1222FILTOG	1"	10	15,600
1222FILTGB	1" 1/4"	5	20,160



Raccordo cassone diritto in ottone nudo

Straight connector for tank in yellow brass

cod.	misura	pz. x conf.	euro cad.
12230000D	1/2"	20	7,796
12230000F	3/4"	15	10,260
12230000G	1"	8	14,776
12230000GB	1" 1/4	5	20,724
12230000GD	1" 1/2	4	26,676
12230000H	2"	3	35,912



Copriforo in ottone cromato con guarnizione, o'ring e ghiera di fissaggio

Chrome plated brass hole-cover with gasket, o'ring and fixing nut

cod.	misura	pz. x conf.	euro cad.
1306T00000	50 mm	20	2,000



Copriforo smaltato bianco con guarnizione, o'ring e ghiera di fissaggio

Glazed white chrome plated hole-cover with gasket, o'ring and fixing nut

cod.	misura	pz. x conf.	euro cad.
1306COLBIA	50 mm	20	2,000



Copriforo in acciaio con guarnizione

Chrome plated brass hole-cover with gasket

cod.	misura	pz. x conf.	euro cad.
1301G00000	44 mm	50	1,320



Cappuccio universale

Universal cap

cod.	pz. x conf.	euro cad.
1237000000	10	8,191





Canotto in ottone cromato

Chrome plated brass pipe

cod.	misura	pz. x conf.	euro cad.
1227026X20	26x200 mm	10	2,331
1227026X25	26x250 mm	10	2,804
1227026X30	26x300 mm	10	3,285
1227030X20	30x200 mm	10	2,485
1227030X25	30x250 mm	10	2,972
1227030X30	30x300 mm	10	3,453
1227032X20	32x200 mm	10	2,668
1227032X25	32x250 mm	10	3,256
1227032X30	32x300 mm	10	3,795
1227040X20	40x200 mm	10	4,711
1227040X25	40x250 mm	10	5,747
1227040X30	40x300 mm	10	6,890
122726X100	26x1000 mm	10	11,232
122730X100	30x1000 mm	10	12,021
122732X100	32x1000 mm	10	13,184
122740X100	40x1000 mm	10	22,225



Canotto con battuta in ottone cromato

Chrome plated brass pipe with shoulder

cod.	misura	pz. x conf.	euro cad.
1228026X20	26x200 mm	10	2,581
1228026X25	26x250 mm	10	3,014
1228026X30	26x300 mm	10	3,452
1228030X20	30x200 mm	10	2,739
1228030X25	30x250 mm	10	3,268
1228030X30	30x300 mm	10	3,732
1228032X20	32x200 mm	10	2,857
1228032X25	32x250 mm	10	3,347
1228032X30	32x300 mm	10	3,885
1228040X20	40x200 mm	10	4,818
1228040X25	40x250 mm	10	5,850
1228040X30	40x300 mm	10	6,972



Canotto con attacco a pipa in ottone cromato

Chrome plated brass pipe with connection

cod.	misura	pz. x conf.	euro cad.
1229026X20	26x200 mm	10	5,349
1229026X25	26x250 mm	10	6,195
1229026X30	26x300 mm	10	7,038
1229030X20	30x200 mm	10	5,349
1229030X25	30x250 mm	10	6,195
1229030X30	30x300 mm	10	7,038
1229032X20	32x200 mm	10	5,821
1229032X25	32x250 mm	10	6,771
1229032X30	32x300 mm	10	7,712



Canotto curvo in ottone cromato

Chrome plated brass bended pipe

cod.	misura	pz. x conf.	euro cad.
1230026X15	26x150x250 mm	10	6,646
12300026X1	26x150x300 mm	10	7,508
1230026X20	26x200x250 mm	10	7,508
123026X250	26x250x300 mm	10	9,288
1230030X15	30x150x250 mm	10	6,646
123030X150	30x150x300 mm	10	7,508
1230030X20	30x200x250 mm	10	7,508
123030X250	30x250x300 mm	10	9,288
1230032X15	32x150x250 mm	10	7,459
123032X300	32x150x300 mm	10	8,391
1230032X20	32x200x250 mm	10	8,391
123032X250	32x250x300 mm	10	10,391



Canotto in ottone cromato con curva 45°

Chrome plated brass pipe with bend 45°

cod.	misura	pz. x conf.	euro cad.
1233030X10	30x100x140 mm	10	4,625
1233030X14	30x140x140 mm	10	5,279
1233030X16	30x160x160 mm	10	6,249



Canotto flessibile cromato

Chrome plated flexible copper pipe

cod.	misura	pz. x conf.	euro cad.
1231026X20	26x200 mm	10	3,329
1231026X25	26x250 mm	10	5,133
1231026X30	26x300 mm	10	5,493
1231030X20	30x200 mm	10	3,671
1231030X25	30x250 mm	10	5,600
1231030X30	30x300 mm	10	6,547
1231032X20	32x200 mm	10	3,787
1231032X25	32x250 mm	10	5,787
1231032X30	32x300 mm	10	6,720



Canotto con spostamento da 25 mm in ottone cromato

Chrome plated brass pipe with 25 mm off set

cod.	misura	pz. x conf.	euro cad.
1235000030	30 mm	10	7,652
1235000032	32 mm	10	8,271



Rosone in ottone cromato per canotti eccentrici

Chrome plated brass rosette for excentric pipe

cod.	misura	pz. x conf.	euro cad.
1236000026	26 mm	100	3,898
1236000030	30 mm	100	3,898
1236000032	32 mm	100	3,898



Prolunga per canotto in ottone cromato con o'ring

Chrome plated brass extension with o'ring

cod.	misura	pz. x conf.	euro cad.
1238NT0026	26x130 mm	10	3,392
1238NT0030	30x130 mm	10	3,616
1238NT0032	32x130 mm	10	3,689
1238NT0040	40x130 mm	10	4,930



Canotto in ottone cromato con flangia maggiorata per sifoni da 1"1/4

Chrome plated pipe with brass nut oversized flange for siphon size 1"1/4

cod.	misura	pz. x conf.	euro cad.
4013000000	26x250 mm	10	5,100
4013CD0000	26x250 mm con dado ottone	10	7,756



Canotto in ottone cromato per scarico lavatrice/lavastoviglie

Chrome plated brass pipe for washing and dishwasher inlet pipe

cod.	misura	pz. x conf.	euro cad.
1358C26X25	26x250 mm	10	11,880
1358C30X25	30x250 mm	10	12,100
1358C32X25	32x250 mm	10	12,400



Raccordo portagomma lavatrice/lavastoviglie cromato

Chromed double fitting for washing and dishwasher

cod.	misura	pz. x conf.	euro cad.
1352ACR000	1"	10	1,800



Giunto ridotto in ottone nudo per tubi piombo a saldare

Yellow brass connection for drain pipe, with o'ring

cod.	misura	pz. x conf.	euro cad.
6001000032	32 mm ridotto 26 mm	10	2,996
6001000040	40 mm ridotto 32 mm	10	3,655



Giunto ridotto in ottone cromato per tubi piombo

Chrome plated brass connection for drain pipe, with o'ring

cod.	misura	pz. x conf.	euro cad.
6001000001	32 mm ridotto 26 mm	10	3,413
6001000002	40 mm ridotto 32 mm	10	4,012



Giunto a saldare in ottone nudo

Yellow brass connection for drain pipe, with o'ring on both sides

cod.	misura	pz. x conf.	euro cad.
6000000026	26 mm	10	1,438
6000000030	30 mm	10	1,596
6000000032	32 mm	10	1,702
6000000040	40 mm	10	2,234



Prolunga in ottone cromato per canotto con o'ring di tenuta

Chrome plated brass connection for pipe, with o'rings on both sides

cod.	misura	pz. x conf.	euro cad.
6002000026	26 mm	10	2,128
6002000030	30 mm	10	2,447
6002000032	32 mm	10	2,609
6002000040	40 mm	10	3,723



Giunto in ottone cromato ridotto con o'ring di tenuta

Chrome plated brass connection, fixing o'ring on both sides

cod.	misura	pz. x conf.	euro cad.
6001CR3226	32x26 mm	10	3,663
6001CR4032	40x32 mm	10	4,162



Manicotto in gomma nera per giunzione canotto

Black rubber tube connection

cod.	misura	pz. x conf.	euro cad.
6004G26X26	26x26 mm	10	1,104
6004G26X32	26x32 mm	10	0,800
6004G32X32	32x32 mm	10	1,412
6004G40X26	40x26 mm	10	1,196
6004G40X32	40x32 mm	10	0,908
6004G40X40	40x40 mm	10	0,908



Giunzione in PP bianco con 2 ghiera e guarnizione di tenuta

White PP connection with 2 nuts and fixing gasket

cod.	misura	pz. x conf.	euro cad.
6004PL0026	26x26 mm	10	4,240
6004PL2632	26x32 mm	10	4,772
6004PL0032	32x32 mm	10	4,240
6004PL3240	40x32 mm	10	4,772
6004PL0040	40x40 mm	10	4,772



Rosetta per rubinetto in ottone cromato Ø 60 mm

Sink chrome plated brass rosette Ø 60 mm

cod.	misura	pz. x conf.	euro cad.
125000000C	3/8"	100	0,464
125000000D	1/2"	100	0,480

Rosetta per rubinetto in acciaio inox Ø 60 mm

Stainless steel sink rosette Ø 60 mm

cod.	misura	pz. x conf.	euro cad.
1250I0000C	3/8"	100	0,128
1250I0000D	1/2"	100	0,128



Rosetta per rubinetto tipo sagomato in ottone cromato Ø 60 mm

Rosette for sink "shaped type" in chrome plated brass Ø 60 mm

cod.	misura	pz. x conf.	euro cad.
125100000C	3/8"	100	0,424
125100000D	1/2"	100	0,440

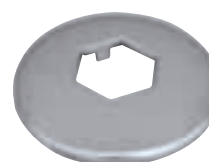

Rosetta foro esagonale

Rosette with hexagonal hole

cod.	misura	pz. x conf.	euro cad.
5003I0000C	3/8"	100	0,207
5003I0000D	1/2"	100	0,207



Rosetta per rubinetto tipo maggiorato in ottone cromato Ø 70 mm

Rosette for sink "oversize type" in chrome plated brass Ø 70 mm

cod.	misura	pz. x conf.	euro cad.
1250GS000C	3/8"	100	0,760
1250GS000D	1/2"	100	0,760
1250GS000F	3/4"	100	0,760
1250GS000G	1"	100	0,760



**Rosetta per canotto
in ottone cromato Ø 75 mm**

Rosette for pipe in chrome
plated brass Ø 75 mm

cod.	misura	pz. x conf.	euro cad.
1252000026	foro 26 mm	25	0,978
1252000030	foro 30 mm	25	0,978
1252000032	foro 32 mm	25	0,978



**Rosetta tipo conico per canotto
in ottone cromato Ø 77 mm**

Rosette for pipe "conical type"
in chrome plated brass external Ø 77 mm

cod.	misura	pz. x conf.	euro cad.
1253000026	foro 26 mm	50	1,497
1253000030	foro 30 mm	50	1,497
1253000032	foro 32 mm	50	1,497
1253000040	foro 40 mm	50	1,497



**Rosetta ovale gigante
tipo "C" in ottone cromato**

Chrome plated brass gigant oval rosette "C" type

cod.	misura	pz. x conf.	euro cad.
12550VCATI	Ø est. 95 mm	10	2,608



**Rosetta in ottone cromato
a scatola Ø 60 mm**

Chrome plated "box shape"
rosette external Ø 60 mm

cod.	misura	pz. x conf.	euro cad.
1254000C10	h 10 mm Ø int. 3/8"	50	0,888
1254000C15	h 15 mm Ø int. 3/8"	50	1,028
1254000C20	h 20 mm Ø int. 3/8"	50	1,216
1254000D10	h 10 mm Ø int. 1/2"	50	0,836
1254000D15	h 15 mm Ø int. 1/2"	50	0,968
1254000D20	h 20 mm Ø int. 1/2"	50	1,144
1254000D30	h 30 mm Ø int. 1/2"	50	1,936
1254000F10	h 10 mm Ø int. 3/4"	15	0,888
1254000F15	h 15 mm Ø int. 3/4"	15	1,028
1254000F20	h 20 mm Ø int. 3/4"	15	1,320



**Rosetta in ottone cromato
tipo apribile Ø 55 mm**

Chrome plated "openable type"
rosette Ø 55 mm

cod.	misura	pz. x conf.	euro cad.
1256000010	Ø int. 10 mm	50	1,348
1256000012	Ø int. 12 mm	50	1,348
1256000014	Ø int. 14 mm	50	1,348
1256000016	Ø int. 16 mm	50	1,348
125600000C	Ø int. 3/8"	50	1,248
125600000D	Ø int. 1/2"	50	1,248
125600000F	Ø int. 3/4"	50	1,636
125600000G	Ø int. 1"	50	1,636
125600000GB	Ø int. 1"1/4	50	1,952



**Piastra rettangolare per passo
rapido in ottone cromato**

Rectangular chrome plated brass plate

cod.	misura	pz. x conf.	euro cad.
1261005X25	h 5 mm Ø int. 25 mm	10	3,840
1261005X28	h 5 mm Ø int. 28 mm	10	4,400
1261010X25	h 10 mm Ø int. 25 mm	10	6,392
1261010X28	h 10 mm Ø int. 28 mm	10	6,972
1261015X25	h 15 mm Ø int. 25 mm	10	7,504
1261015X28	h 15 mm Ø int. 28 mm	10	7,504
1261020X25	h 20 mm Ø int. 25 mm	10	7,388
1261020X28	h 20 mm Ø int. 28 mm	10	7,388



**Piastra rotonda per passo rapido
in ottone cromato altezza 20mm**

Chrome plated round plate high 20mm

cod.	misura	pz. x conf.	euro cad.
1262020X25	Ø int. 25 mm	10	3,960
1262020X28	Ø int. 28 mm	10	4,188





Rosetta apribile in PP bianco Ø 60 mm
White PP "openable" rosette Ø 60 mm

cod.	misura	pz. x conf.	euro cad.
1257B00010	Ø int. 10 mm	200	0,095
1257B00012	Ø int. 12 mm	200	0,095
1257B00014	Ø int. 14 mm	200	0,095
1257B00016	Ø int. 16 mm	200	0,095
1257B00018	Ø int. 3/8" (18 mm)	200	0,095
1257B0000D	Ø int. 1/2"	200	0,180

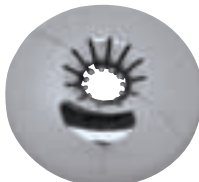

Rosetta Lux apribile in ABS cromata
Universal chromed ABS Lux openable rosette

cod.	pz. x conf.	euro cad.
22271L00CR	100	0,690

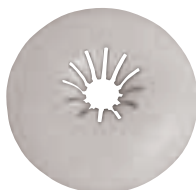

Rosetta Lux apribile in ABS bianca
Universal white ABS Lux openable rosette

cod.	pz. x conf.	euro cad.
22271L0000	100	0,300



Rosetta apribile universale in PP bianco
Openable universal white PP rosette

cod.	pz. x conf.	euro cad.
1257NT000B	200	0,095



Rosetta apribile universale in PP bianco per monotubo
Openable universal white PP rosette for single pipe

cod.	pz. x conf.	euro cad.
1257NTD00B	50	0,419



Rosetta apribile copritubo "Futura" in PP bianco per termosifone

Openable white PP pipe-cover rosette "Futura" for radiator

cod.	pz. x conf.	euro cad.
1259000000	30	0,351

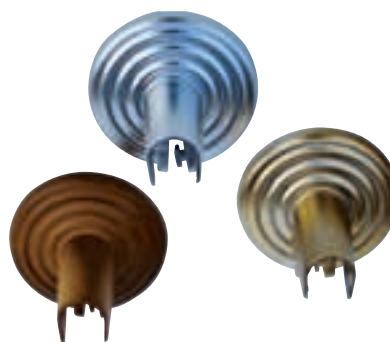

Rosetta apribile copritubo "Futura" in PP bianco Ø interno variabile da 10 a 22 mm

Openable white PP rosette "Futura" for radiator internal variable Ø from 10 to 22 mm

cod.		pz. x conf.	euro cad.
1259CROM00	cromo	30	1,935
1259LEGN00	legno	30	1,935
1259MARM00	marmo	30	1,935
1259BRONZO	bronzo	30	1,935



Rosetta apribile copritubo "Futura" in PP bianco per monotubo

Openable white PP pipe-cover rosette "Futura" for single pipe

cod.	pz. x conf.	euro cad.
1259D00000	7	0,585



Rosetta universale tipo "P"

Universal rosette "P" type

cod.		pz. x conf.	euro cad.
1259P00000	bianca	50	0,392
1259PCR000	cromata	20	3,404

VALVOLAME E RUBINETTERIA

VALVES AND FAUCETS



**Curvetta sottolavabo
con rosetta**

Elbow connection with rosette

cod.	misura	pz. x conf.	euro cad.
1334ITA00D	1/2"x10	10	5,008



**Curvetta sottolavabo
stampata con rosetta**

Forged elbow connection
with rosette

cod.	misura	pz. x conf.	euro cad.
1334NTBOCG	1/2"x10 "ECO"	10	4,552
1334NT000D	1/2"x10	10	5,289



**Curvetta sottolavabo in ottone
con rosone, nipples e dado conico**

Brass elbow connection
with rosette, nipples and conic nut

cod.	misura	pz. x conf.	euro cad.
G028380000	1/2"x10	10	6,270



**Curvetta sottolavabo in ottone
con rosone, nipples e dado alto**

Brass elbow connection
with rosette, nipples and high nut

cod.	misura	pz. x conf.	euro cad.
G028400000	1/2"x10	10	6,600



**Curvetta sottolavabo stampata
in ottone cromato con rosetta**

Forged chrome plated elbow brass
connection with flange

cod.	misura	pz. x conf.	euro cad.
133600000D	1/2"x10	10	4,280



Curva in ottone cromato con rosetta

Chrome plated brass elbow connection with rosette

cod.	misura	pz. x conf.	euro cad.
138400000	M1/2"xM1/2"	20	2,312



cod.	misura	pz. x conf.	euro cad.
1384Q00000	M1/2"xM1/2"	10	18,000



cod.	misura	pz. x conf.	euro cad.
1384L00000	M1/2"xM1/2"	10	2,920



cod.	misura	pz. x conf.	euro cad.
1384IT0060	M1/2"xM1/2"	10	16,000



Curva in ottone cromato
Chrome plated brass elbow connection size

cod.	misura	pz. x conf.	euro cad.
1384A00000	M1/2"xM3/4"	10	4,056



Rubinetto sottolavabo con filtro "ECO"

"ECO" angle valve with filter

cod.	misura	pz. x conf.	euro cad.
1335SCDD00	1/2"x1/2"	10	6,667
1335SCDC00	1/2"x3/8"	10	6,667



Rubinetto sottolavabo a sfera con filtro e rosetta "ECO"

"ECO" ball angle valve with filter and rosette

cod.	misura	pz. x conf.	euro cad.
1335MB01CG	1/2"	10	7,111



Rubinetto sottolavabo in ottone cromato a vitone con filtro, snodo e rosetta

Screw chrome plated brass ball angle valve with filter, ball joint and rosette

cod.	misura	pz. x conf.	euro cad.
1335LUVITD	1/2"x10	10	9,900



Rubinetto sottolavabo in ottone cromato a vitone con filtro, snodo e rosetta "ECO"

"ECO" Screw chrome plated brass ball angle valve with filter, ball joint and rosette

cod.	misura	pz. x conf.	euro cad.
1335LUV00D	1/2"x10	10	6,500



Rubinetto sottolavabo in ottone cromato a sfera con filtro, snodo e rosetta "ECO"

"ECO" Chrome plated angle valve with filter, ball joint and rosette

cod.	misura	pz. x conf.	euro cad.
1335LUS00D	1/2"x10	10	6,300

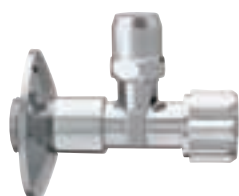

Rubinetto sottolavabo in ottone cromato a vitone con rosetta

Chrome plated brass angle valve with screw and rosette

cod.	misura	pz. x conf.	euro cad.
1335VIT000	1/2"x10	10	4,600

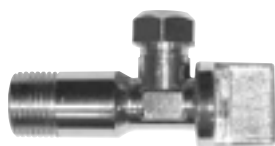

Rubinetto sottolavabo a sfera con rosetta
Angle ball valve with rosette

cod.	misura	pz. x conf.	euro cad.
1335SFE000	1/2"x10	10	4,000
1335SFE00D	1/2"x1/2"	10	3,556



Rubinetto sottolavabo
Angle valve

cod.	misura	pz. x conf.	euro cad.
1335SUP0DD	1/2"x1/2"	10	20,000
1335SUPC10	1/2"x10	10	21,600
1335SUP0DC	1/2"x3/8"	10	20,000



Rubinetto a sfera 3 vie con attacco lavatrice

Angle valve three ways with washing machine connection

cod.	misura	pz. x conf.	euro cad.
13353VIE00	M1/2"xF1/2"xM3/4"	10	5,803



Rubinetto a squadra con codulo per cassetta wc

Square faucet with tang for wc cistern

cod.	pz. x conf.	euro cad.
138600000C	10	5,040



Rubinetto a squadra con codulo per cassetta wc completo di prolunga, nipples e rosone con raccordo

Square faucet with tang for wc cistern complete with extension nipple and rosette with connection

cod.	misura	pz. x conf.	euro cad.
1386COM00C	3/8"	10	8,988
1386COM000	1/2"	10	9,280



Rubinetto cromato per cassetta wc completo di prolunghe, nipples e rosone con raccordo

Chromed faucet with tang for wc cistern complete with extension nipple and rosette with connection

cod.	misura	pz. x conf.	euro cad.
133000000C	3/8"	10	10,332
1330000000	1/2"	10	10,744



**Rubinetto lavatrice
in ottone cromato a sfera con rosetta**
Chrome plated brass washing machine
ball angle valve with rosette

cod.	misura	pz. x conf.	euro cad.
127100000D	1/2"x3/4"	10	5,004



**Rubinetto lavatrice in ottone cromato
a sfera con maniglia ABS con rosetta**
Chrome plated brass washing machine ball valve
with ABS handle with rosette

cod.	misura	pz. x conf.	euro cad.
1271NTLAOD	1/2"x3/4"	10	5,676



**Rubinetto in ottone cromato combinato
sottolavabo/lavatrice con rosone**
Combined washing machine and under basin
chrome plated brass angle valve with rosette

cod.	misura	pz. x conf.	euro cad.
1271KOMB00	1/2"x3/4"	10	17,480



**Rubinetto serie in ottone cromato combinato
sottolavabo/lavatrice con rosone "ECO"**
"ECO" Combined washing machine and under
basin chrome plated brass angle valve with rosette

cod.	misura	pz. x conf.	euro cad.
1271KOMBE0	1/2"x3/4"	10	12,008



**Rubinetto in ottone cromato a sfera per
contenitori olio**

Chrome plated brass ball bibcock for oil tank

cod.	misura	pz. x conf.	euro cad.
1271B0000D	1/2"	10	5,625



**Rubinetto lavatrice
a crociera 3 vie a vitone**

Washing machine angle valve with screw 3 ways

cod.	misura	pz. x conf.	euro cad.
13710I000C	3/8"x3/4"	12	13,748
13710I000D	1/2"x3/4"	12	13,748

cod.	misura	pz. x conf.	euro cad.
137100000D	1/2"x3/4"	12	7,275

"ECO"



**Rubinetto lavatrice
angolo orizzontale a vitone**

Washing machine angle valve with screw

cod.	misura	pz. x conf.	euro cad.
13720I000D	1/2"x3/4"	12	12,928

cod.	misura	pz. x conf.	euro cad.
137200000D	1/2"x3/4"	12	8,750

"ECO"



**Rubinetto arresto
boiler a vitone**

Stop-bibcock with screw for boiler

cod.	misura	pz. x conf.	euro cad.
1373000FFD	FF1/2"x1/2"	12	8,751

"ECO"

cod.	misura	pz. x conf.	euro cad.
1373000MFD	MF1/2"x1/2"	12	8,751

"ECO"



Rubinetto doppio attacco lavatrice a vitone

Double washing machine angle valve with screw

cod.	misura	pz. x conf.	euro cad.
13780I000C	3/8"x3/4"	12	26,676
13780I000D	1/2"x3/4"	12	26,676

cod.	misura	pz. x conf.	euro cad.
137800000D	1/2"x3/4"	12	15,281

"ECO"



Rubinetto a vitone con snodo e attacco lavatrice

Washing machine angle valve with screw and ball joint

cod.	misura	pz. x conf.	euro cad.
13790I000C	3/8"x3/4"	12	33,652
13790I000D	1/2"x3/4"	12	33,652

cod.	misura	pz. x conf.	euro cad.
137900000D	1/2"x3/4"	12	15,464

"ECO"



Rubinetto a vitone con snodo

Angle valve with screw and ball joint

cod.	misura	pz. x conf.	euro cad.
1379AOI00C	3/8"	12	23,188
1379AOI00D	1/2"	12	23,188

cod.	misura	pz. x conf.	euro cad.
1379A0000D	1/2"	12	11,200

"ECO"



Rubinetto lavello a parete

Wall basin valve

cod.	pz. x conf.	euro cad.
1379GLO00D	1	30,000



Rubinetto lavello a parete con canna "U"

Wall basin valve with "U" barrel

cod.	pz. x conf.	euro cad.
1379GLU00D	1	30,000



Rubinetto monolavello

Single lever sink

cod.	pz. x conf.	euro cad.
1379B00000	1	20,000





Rubinetto monolavello con doppia maniglia
Single lever sink with double handle

cod.	pz. x conf.	euro cad.
1379B20000	1	27,200



Rubinetto temporizzato per orinatoio
Temporized faucet for urinals

cod.	pz. x conf.	euro cad.
1379T10000	1	21,040



Rubinetto temporizzato per lavabo
Temporized faucet for wash basin

cod.	pz. x conf.	euro cad.
1379T20000	1	27,792



Rubinetto temporizzato a muro
Wall temporized faucet

cod.	pz. x conf.	euro cad.
1379T30000	1	26,136



Distanziatore in ottone cromato per retrogruppo
Chrome plated brass lavatory angle valve

cod.	misura	pz. x conf.	euro cad.
1380000000	M3/4"xF3/4"	10	10,444



Distanziatore in ottone cromato per retrogruppo con rubinetto lavatrice
Chrome plated brass lavatory angle tap MxMxF

cod.	misura	pz. x conf.	euro cad.
1380CP0000	M3/4"xM3/4"xF3/4"	10	12,000



Coppia distanziatori in ottone cromato con dado girevole, con e senza foro 3/8"

Set two pieces chrome plated brass connections with rotating nut, with and without hole 3/8"

cod.	misura	cp. x conf.	euro cp.
1382NT0000	M3/4"xF3/4"	10	16,889



Coppia distanziatori in ottone cromato con e senza foro 3/8"

Set two pieces chrome plated brass connections with and without hole 3/8"

cod.	misura	cp. x conf.	euro cp.
1382000000	M3/4"xF3/4"	10	9,563



Rubinetto portagomma in ottone cromato a sfera

Chrome plated brass ball angle valve with rubber holder

cod.	misura	pz. x conf.	euro cad.
5037000000	1/2"	20	6,012
503700000F	3/4"	10	8,492
503700000G	1"	5	13,444



**Portagomma
Rubber holder**

cod.	misura	pz. x conf.	euro cad.
5037COD00D	3/4"x rub. 1/2"	20	0,400
5037COD00F	1"x rub. 3/4"	10	0,618
5037COD00G	1 1/4 x rub. 1"	5	1,044



**Rubinetto artistico a vitone con rosetta
Artistic tap with rosette**

cod.	misura	pz. x conf.	euro cad.
CA04000000	1/2"	5	28,650



Rubinetto artistico a sfera con rosetta

Artistic ball tap with rosette

cod.	misura	pz. x conf.	euro cad.
CA05000000	1/2"	5	28,650



Rubinetto in ottone nudo senza portagomma

Yellow brass faucet without rubber holder

cod.	misura	pz. x conf.	euro cad.
5035SP0000	M1/2"	10	9,840



Rubinetto in ottone nudo con portagomma

Yellow brass faucet with rubber holder

cod.	misura	pz. x conf.	euro cad.
5035000000	M1/2"	10	10,000



Minivalvola a sfera in ottone cromato con maniglia cromata

Chrome plated brass mini-ball valve with chromed handle

cod.	misura	pz. x conf.	euro cad.
1402CROFFC	FF3/8"	20	3,556
1402CROFFD	FF1/2"	20	4,267



Minivalvola a sfera in ottone cromato con maniglia cromata

Chrome plated brass mini-ball valve with chromed handle

cod.	misura	pz. x conf.	euro cad.
1403CROMFC	MF3/8"	20	3,556
1403CROMFD	MF1/2"	20	4,089



Minivalvola a sfera in ottone cromato con maniglia nera

Chrome plated brass mini ball valve with black handle

cod.	misura	pz. x conf.	euro cad.
1402NROFFC	FF3/8"	20	3,644
1402NROFFD	FF1/2"	20	4,533



Minivalvola a sfera in ottone cromato con maniglia nera

Chrome plated brass mini ball valve with black handle

cod.	misura	pz. x conf.	euro cad.
1403NROMFC	MF3/8"	20	3,556
1403NROMFD	MF1/2"	20	4,089



Presca rapida in ottone per tubo

Chrome plated brass fast punch for pipe

cod.	misura	pz. x conf.	euro cad.
661200000D	1/2"x1/2"	20	9,300
661200000F	3/4"x1/2"	20	11,960
661200000G	1"x1/2"	20	16,800
661200000GB	1"1/4"	20	29,991



Valvola a sfera FF in ottone tipo "ECO"

"ECO" Chrome plated brass ball valve FF

cod.	misura	pz. x conf.	euro cad.
240000000D	1/2"	24	4,600
240000000F	3/4"	14	6,600
240000000G	1"	10	12,800
240000000GB	1"1/4"	4	16,000
240000000GD	1"1/2"	3	26,520
240000000H	2"	2	36,800
240000000HD	2"1/2"	2	84,000
240000000I	3"	2	124,000
240000000L	4"	2	192,000



Valvola a sfera MF in ottone tipo "ECO"

"ECO" Chrome plated brass ball valve MF

cod.	misura	pz. x conf.	euro cad.
24M000000D	1/2"	24	4,800
24M000000F	3/4"	14	7,200
24M000000G	1"	10	12,800
24M000000GB	1"1/4"	4	18,800
24M000000GD	1"1/2"	3	30,400
24M000000H	2"	2	43,200



Valvola a sfera FF in ottone con maniglia a farfalla "ECO"

"ECO" Chrome plated brass ball valve FF butterfly handle

cod.	misura	pz. x conf.	euro cad.
250000000D	1/2"	24	4,400
250000000F	3/4"	20	6,400
250000000G	1"	14	11,296



Valvola a sfera MF in ottone con maniglia a farfalla "ECO"

"ECO" Chrome plated brass ball valve MF butterfly handle

cod.	misura	pz. conf.	euro cad.
25M000000D	1/2"	24	5,169
25M000000F	3/4"	20	7,342
25M000000G	1"	10	14,387

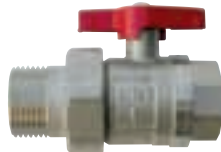

Valvola a sfera con bocchettone "ECO"

"ECO" Ball valve with pipe union "ECO"

cod.	misura	pz. x conf.	euro cad.
25BOC0000D	1/2"	10	7,592
25BOC0000F	3/4"	10	11,296
25BOC0000G	1"	5	18,364



Filtro a "Y" in ottone nudo

Yellow brass "Y" filter

cod.	misura	pz. x conf.	euro cad.
1335FYDD00	1/2"	10	4,348
1335FYFF00	3/4"	10	7,302
1335FYGG00	1"	5	10,001



Cappuccio cromato per rubinetto

Chrome plated brass cap for tap

cod.	pz. x conf.	euro cad.
2628B00000	10	5,423



Maniglia cromata per rubinetto

Chrome plated handle for faucet

cod.	pz. x conf.	euro cad.
2627/00000	10	6,952



Blister pronto intervento per vitone rubinetto

Emergency repair kit for mixer screw

cod.	pz. x conf.	euro cad.
2068000000	10	19,718



Blister pronto intervento passo rapido

Emergency repair kit for swift pitch

cod.	pz. x conf.	euro cad.
2069000000	10	39,100



Vitone passo rapido asta fissa da d.26 a d.36

Mixer screw rapid pitch with fixed rod from d.26 till d.36

cod.	pz. x conf.	euro cad.
2067M00026	5	27,544
2067M00027	5	27,544
2067M00028	5	27,544
2067M00029	5	27,544
2067M00030	5	27,544
2067M00031	5	29,240
2067M00032	5	29,240
2067M00033	5	29,240
2067M00034	5	29,240
2067M00035	5	29,240
2067M00036	5	29,240

COMPLEMENTI PER CASSETTE DI SCARICO

ACCESSORIES FOR WC CISTERN



Rubinetto galleggiante a 5 copiglie in ottone nudo

5 cotter - pins float tap in yellow brass

cod.	misura	pz. x conf.	euro cad.
127300000C	3/8"	10	9,196
127300000D	1/2"	10	9,696



Rubinetto galleggiante a 5 copiglie in ottone nudo senza dado e codulo asta piatta

5 cotter - pins float tap in yellow brass without nut and tang, flat rod

cod.	misura	pz. x conf.	euro cad.
127400000F	3/4"	10	12,356
127400000G	1"	10	17,252
127400000GB	1"1/4	5	41,844
127400000GD	1"1/2	5	53,672
127400000H	2"	3	74,800



Rubinetto galleggiante silenzioso in ottone nudo per alte pressioni senza dado e codulo, con sede in inox con asta piatta

Yellow brass noiseless float tap for high pressure without nut and tang inox seat with flat rod

cod.	misura	pz. x conf.	euro cad.
127500000F	3/4"	10	39,428
127500000G	1"	10	41,376
127500000GB	1"1/4	5	78,340
127500000GD	1"1/2	5	80,848
127500000H	2"	3	128,028



Rubinetto galleggiante silenzioso in ottone nudo con sede in inox e asta regolabile

Yellow brass noiseless float tap with inox seat and adjustable rod

cod.	misura	pz. x conf.	euro cad.
127600000C	3/8"	10	9,288
127600000D	1/2"	10	10,352



Rubinetto galleggiante silenzioso in ottone nichelato con sfera

Nichel plated brass noiseless float tap with inox seat

cod.	misura	pz. x conf.	euro cad.
128100000C	3/8"	10	8,621
128100000D	1/2"	10	9,653



Rubinetto galleggiante in ottone nudo "Tipo Inglese"

Yellow brass float tap "English type"

cod.	misura	pz. x conf.	euro cad.
129200000D	1/2"	10	12,828
129200000F	3/4"	10	14,044
129200000G	1"	5	20,428



Rubinetto galleggiante in materiale plastico antiurto tipo "Universale" con vite regolabile

Float tap in plastic shock proof material "Universal" type with adjustable screw

cod.	misura	pz. x conf.	euro cad.
1287000000	3/8"	10	6,640



Rubinetto galleggiante in materiale plastico antiurto con sfera scorrevole

Float tap in plastic shock proof material sliding ball joint

cod.	misura	pz. x conf.	euro cad.
1286000000	3/8"	10	2,871



Batteria universale a comando pneumatico con guarnizioni, accessori di fissaggio e galleggiante

Universal battery with pneumatic control with gasket, fixing accessories and floating

cod.	pz. x conf.	euro cad.
2410NT0000	5	15,769



Sfera galleggiante in moplen 90 mm con nottolino in ottone

Moplen floating sphere 90 mm pawl and thread

cod.	misura.	pz. x conf.	euro cad.
128800000F	1/4"	50	0,639
128800000C	1/4"	50	0,878



Sfera galleggiante in moplen tonda 90 mm per acqua fredda con nottolino in ottone

Moplen floating sphere 90 mm for cold water with brass pawl and thread

cod.	pz. x conf.	euro cad.
1288TAF090	50	0,720
1288TAF115	20	1,680



Sfera galleggiante in moplen tonda con asola per asta piatta e vite fissaggio

Moplen floating round sphere with slot for flat rod and fixing screw

cod.	misura	pz. x conf.	euro cad.
1289000120	120 mm	20	1,908
1289000150	150 mm	20	2,547
1289000180	180 mm	15	3,272
1289000220	220 mm	6	7,038
1289000300	300 mm	2	20,250



Sfera per galleggiante in moplen brevettata con doppio attacco

Patented moplen sphere for floating with double connection

cod.	misura	pz. x conf.	euro cad.
1289NT0120	120 mm	20	1,890



**Sfera per galleggiante in rame
con noddolino in ottone saldato e vite**

Copper sphere for floating
with chromed plated brass and screw



cod.	misura	pz. x conf.	euro cad.
129NOT085	85	50	6,380
129NOT090	90	50	6,580
129NOT100	100	50	7,520
129NOT120	120	20	13,760
129NOT150	150	20	19,800
129NOT180	180	15	28,600
129NOT200	200	6	35,280
129NOT220	220	6	47,000
129NOT250	250	3	63,200
129NOT300	300	2	97,200

**Copiglia in ottone nudo
lunghezza 20 mm**

Yellow brass cotter-pin length 20 mm



cod.	pz. x conf.	euro cad.
5007000020	100	0,200

**Vite in ottone nudo
per sfere in plastica**

Yellow brass screw for plastic sphere



cod.	pz. x conf.	euro cad.
5007VIT000	50	0,467



**Tubo di cacciata in materiale plastico, curva
inclinata 90° al vaso e 45° alla cassetta**

Flushing pipe in plastic material, variable curve
90° to the wc bowl and 45° to the cistern

cod.	pz. x conf.	euro cad.
0Z00200045	50	7,356

**Tubo di cacciata in materiale plastico, curva
inclinata 90° al vaso e 90° alla cassetta**

Flushing pipe in plastic material, variable curve
90° to the wc bowl and 90° to the cistern

cod.	pz. x conf.	euro cad.
0Z00200090	50	7,356



Tubo di discesa per passo rapido

Descent pipe for fast-pitch

cod.	pz. x conf.	euro cad.
0Z00100000	50	9,600

RICAMBI "STIR BLITZ"

SPARE PARTS FOR "STIR BLITZ"

**Rubinetto galleggiante
in materiale plastico
modello "S"**

Float tap "S" model in plastic material



cod.	pz. x conf.	euro cad.
ST01000000	10	30,288

**Traversino in materiale
plastico con pulsante
senza ghiera modello "S"**

Bar in plastic material with b
without nut, "S" model



cod.	pz. x conf.	euro cad.
ST02000000	10	16,320

**Ghiera cromata per
fissaggio placca modello "S"**

Chromed plated brass
fixing nut plate "S" model

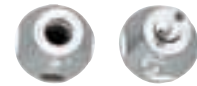

cod.	pz. x conf.	euro cad.
ST03000000	10	17,928

**Levetta in materiale plastico
rinforzata per traversino modello "S"**

Reinforced plastic lever for "S" model bar



cod.	pz. x conf.	euro cad.
ST05000000	10	9,480

**Astina in materiale
plastico per ricambio
pulsante mod. "S"**

Rod in plastic material
for push spare part "S" model



cod.	pz. x conf.	euro cad.
ST06000000	10	15,072

**Ugello in materiale
plastico per galleggiante
modello "S"**



Nozzle in plastic material for floating "S" model

cod.	pz. x conf.	euro cad.
ST07000000	10	10,632

**Placca per cassetta
modello "S"**



Plate for cistern "S" model

cod.	pz. x conf.	euro cad.
ST0800000B	5	16,200
bianca materiale plastico		
ST0800000N	5	21,048
nera materiale plastico		
ST0800000CR	5	36,504
cromata		

**RICAMBI
"RAMO"**

**SPARE PARTS
FOR "RAMO"**

**Rubinetto galleggiante
modello "R" in materiale
plastico per cassetta incasso,
asta regolabile e sfera**



Float tap "R" model in plastic material for embedding cistern, adjustable rod and ball joint

cod.	misura	pz. x conf.	euro cad.
5010000000	3/8"	10	13,076

**Rubinetto galleggiante
modello "R" in materiale
plastico per cassetta incasso,
con attacco passo decimale,
asta regolabile e sfera**



Float tap "R" model in plastic material for embedding cistern with connection, adjustable rod and ball joint

cod.	pz. x conf.	euro cad.
5010PD0000	10	23,016



**Pulsante in ottone cromato per cassetta
modello "R" completo di ghiera di fissaggio**

Chromed plated brass button for cistern "R" model completed with fixing nut

cod.	pz. x conf.	euro cad.
5011000000	5	61,012



**Pulsante in materiale plastico cromato
per cassetta modello "R"
completo di ghiera di fissaggio**

Chromed plastic button for cistern "R" model completed with fixing screw

cod.	pz. x conf.	euro cad.
5012000000	10	10,416



**Rosone in materiale plastico cromato
Ø 110 mm - interno 34 mm**

Rosette in chromed plastic material
Ø 110 mm - internal 34 mm

cod.	pz. x conf.	euro cad.
5013000000	10	9,324

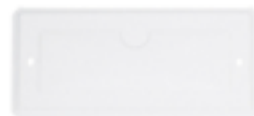

**Piastra in materiale plastico bianco
per cassetta modello "R" attacco basso**

White plastic plate for cistern "R" model low connection

cod.	pz. x conf.	euro cad.
5014000000	5	19,068



**Piastra in materiale plastico bianco
per cassetta modello "R" attacco alto**

White plastic plate for cistern "R" model high connection

cod.	pz. x conf.	euro cad.
5015000000	5	19,068

RICAMBI "DORA"

SPARE PARTS FOR "DORA"



Gruppo placca interna modello "D"
con ghiera di regolazione, molla, perno
filetto e leva alzatubo t/p

Internal plate "D" model with adjustable nut,
spring, threaded bolt and over flow lever

cod.	pz. x conf.	euro cad.
F001000000	10	13,416



Gruppo placca esterna modello "D"
con imbuto e pulsante cromato

External plate "D" model with socket
and chrome plated button

cod.	pz. x conf.	euro cad.
F002000000	10	13,652

**Gruppo placca esterna con ghiera fissa,
placca e pulsante in materiale plastico bianco**

External plate with fixing plate
and white plastic button

cod.	pz. x conf.	euro cad.
F003000000	10	17,776



Rubinetto galleggiante modello "D"
Floating valve model "D"

cod.	pz. x conf.	euro cad.
6500D00000	5	34,020

RICAMBI ORIGINALI "PUCCI"

"PUCCI" ORIGINAL SPARE-PARTS



Rosone bianco

White rosette

cod.	pz. x conf.	euro conf.
1360-----	5	7,728



Canotto prolungato bianco

White extended sleeve

cod.	misura	pz. x conf.	euro conf.
1440-----	cm 26	5	26,936



Canotto prolungato eccentrico bianco

White excentric extended sleeve

cod.	misura	pz. x conf.	euro conf.
1450-----	cm 24	5	32,952



Guarnizione scodellino

Cup-gasket

cod.	pz. x conf.	euro conf.
9001-----	10	4,192



Membrana e due fibre

Two fibers membrane

cod.	pz. x conf.	euro conf.
9002-----	10	16,060



Serie pulsante

Push-button serie

cod.	pz. x conf.	euro cad.
9030-----	1	7,832

Confezione boccola cromata
Packed chromed bushing



cod.	pz. x conf.	euro conf.
9032000000	5	9,748

Confezione rosone e boccola cromati



Packed chrome rosette and bushing

cod.	pz. x conf.	euro cad.
9033000000	1	8,208

Pulsante completo cassetta rame

Complete push button for copper cistern

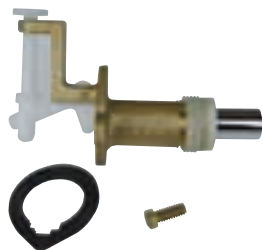

cod.	pz. x conf.	euro cad.
9034000000	1	35,156

Pulsante completo cassetta 6/8

Complete push button for 6/8 cistern



cod.	pz. x conf.	euro cad.
9035000000	1	23,120

Guarnizione sede sfera

Gasket for sphere-seat



cod.	pz. x conf.	euro conf.
9038-----	10	21,396

Confezione sfera di tenuta

Packed seal-sphere



cod.	pz. x conf.	euro cad.
9039000000	1	8,020

Confezione placca bianca

Packed white plate



cod.	pz. x conf.	euro cad.
9066000000	1	16,332

Valvola attacco laterale

Lateral connection valve



cod.	pz. x conf.	euro cad.
9114000000	1	17,956

Valvola completa attacco laterale

Complete valve with lateral connection

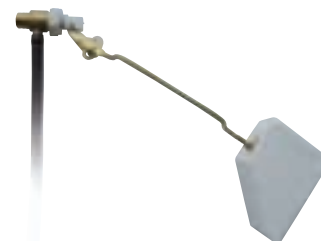

cod.	pz. x conf.	euro cad.
9150000000	1	29,140

Gruppo valvola completo attacco laterale

Complete valve group with lateral connection



cod.	pz. x conf.	euro cad.
9151000000	1	33,892



7

Gruppo valvola completo

Complete valve group

cod.	pz. x conf.	euro cad.
6550000000	1	31,428

Placca con telaio bianca

White plate with frame

cod.	pz. x conf.	euro cad.
6900PLAC00	1	28,472

Serie guarnizioni con membrana

Gasket serie with membrane

cod.	pz. x conf.	euro cad.
9005-----	1	6,208

Dado dx/sx con guarnizione 3/8"

Right / left nut with 3/8" gasket

cod.	pz. x conf.	euro cad.
9016000000	1	7,148

Gambetti - Dadini - Pastiglie cromate

Shanks - nuts - chromed plug nuts

cod.	pz. x conf.	euro cad.
9028000000	10	32,476

Prolunga pulsante 2cm

Push button extension cm 2

cod.	pz. x conf.	euro cad.
9044000000	1	18,228

Prolunga pulsante 3cm

Push button extension cm 3

cod.	pz. x conf.	euro cad.
9045000000	1	19,104

Gambetti prolungati 7cm - dadi - pastiglie

Extended shanks 70m nuts - plug nuts

cod.	pz. x conf.	euro cad.
9048000000	1	8,124

Sportello completo - vite registro Ø 8mm

Complete door - screw Ø 8mm

cod.	pz. x conf.	euro cad.
9062400000	1	15,376

Telaio con tubetti

Frame with pipes

cod.	pz. x conf.	euro cad.
9065000000	1	7,148

Tubetto troppo pieno 47cm per tutti i modelli

Pipe with overflow cm 47 for all models

cod.	pz. x conf.	euro cad.
9074-----	6	17,204

Sportello con inserti Ø 5mm

Door with inserts of Ø 5mm

cod.	pz. x conf.	euro cad.
9076000000	5	24,848

Testina valvola con attacco laterale

Valve head with lateral connection

cod.	pz. x conf.	euro cad.
9125000000	1	7,148

ATTACCHI E FLESSIBILI PER ACQUA, GAS E CONDIZIONAMENTO

CONNECTIONS AND FLEXIBLES FOR WATER, GAS AND CONDITIONING



Rotoli in rame ricotto e cromato

Chrome plated soft copper rolls

cod.	misura	pz. x conf.	euro cad.
1340R00010	10x5000 mm	10	44,484
1340R00012	12x5000 mm	8	54,984
1340R00014	14x5000 mm	5	59,980



Barre in rame ricotto e cromato

Chrome plated soft copper rods

cod.	misura	pz. x conf.	euro cad.
1338B0010A	10x1000 mm	10	7,696
1338B0010B	10x1500 mm	10	10,692
1338B0012A	12x1000 mm	10	9,100
1338B0012B	12x1500 mm	10	13,530
1338B0014A	14x1000 mm	10	11,044
1338B0014B	14x1500 mm	10	15,492



Tubetto liscio rame ricotto e cromato con dado

Chrome plated soft copper smooth pipe with nut

cod.	misura	pz. x conf.	euro cad.
1332S00C20	3/8"x200 mm	25	2,360
1332S00C25	3/8"x250 mm	25	2,600
1332S00C30	3/8"x300 mm	25	2,816
1332S00C35	3/8"x350 mm	25	3,516
1332S00C40	3/8"x400 mm	25	4,132
1332S00C50	3/8"x500 mm	25	4,020
1332S00D20	1/2"x200 mm	25	2,440
1332S00D25	1/2"x250 mm	25	3,052
1332S00D30	1/2"x300 mm	25	3,300
1332S00D35	1/2"x350 mm	25	3,596
1332S00D40	1/2"x400 mm	25	3,692
1332S00D50	1/2"x500 mm	25	4,100



Prolunga per tubetti in rame cromato, calotta conica con guarnizione - gomma e rondella spaccata in ottone 10x300 mm

Chrome plated copper extension for tube,
conic cap with rubber gasket and chrome
plated brass washer 10x300 mm

cod.	misura	pz. x conf.	euro cad.
1332NT0000	3/8"x10	25	4,160



Tubetti sottolavabo Ø 10, rame ricotto cro- mato con raccordo M 10/1

Chromed soft copper pipe Ø 10 with connector
M 10/1

cod.	misura	pz. x conf.	euro cad.
1332PD0300	30 cm	25	2,652
1332PD0350	35 cm	25	2,928
1332PD0400	40 cm	25	3,600
1332PD0500	50 cm	25	4,144



**Squadretta in rame
ricotto e cromato**

Chrome plated soft copper little-square

cod.	misura	pz. x conf.	euro cad.
1339S0010B	Ø 10 150x250 mm	10	3,480
1339S0010E	Ø 10 200x300 mm	10	4,376
1339S0012B	Ø 12 150x250 mm	10	4,236
1339S0012E	Ø 12 200x300 mm	10	5,128
1339S0014B	Ø 14 150x250 mm	10	5,692
1339S0014E	Ø 14 200x300 mm	10	5,884



**Squadretta in rame
ricotto e cromato con
rosone, nipples e dado**

Chrome plated soft copper
little-square with rosette,
nipple and nut

cod.	misura	pz. x conf.	euro cad.
1339000010	Ø 10 150x250 mm	5	6,992
1339000012	Ø 12 150x250 mm	5	8,552
1339000014	Ø 14 150x250 mm	5	9,916



**Kit completo ottone
cromato per scaldabagno**

Chrome plated brass complete kit for boiler

cod.	pz. x conf.	euro cad.
1407000000	5	28,760



**Attacchi flessibili "FF" in treccia acciaio
inox, interno EPDM alimentare**
Flexible hose "FF" in stainless steel plait,
internal EPDM

cod.	misura	pz. x conf.	euro cad.
1325IFCC20	3/8"x3/8"x20 cm	25	2,976
1325IFCC25	3/8"x3/8"x25 cm	25	3,204
1325IFCC30	3/8"x3/8"x30 cm	25	3,436
1325IFCC35	3/8"x3/8"x35 cm	25	3,664
1325IFCC40	3/8"x3/8"x40 cm	25	3,892
1325IFCC50	3/8"x3/8"x50 cm	25	4,352
1325IFCD20	3/8"x1/2"x20 cm	25	3,116
1325IFCD25	3/8"x1/2"x25 cm	25	3,340
1325IFCD30	3/8"x1/2"x30 cm	25	3,560
1325IFCD35	3/8"x1/2"x35 cm	25	3,784
1325IFCD40	3/8"x1/2"x40 cm	25	4,008
1325IFCD50	3/8"x1/2"x50 cm	25	4,452
1325IFDD20	1/2"x1/2"x20 cm	25	3,340
1325IFDD25	1/2"x1/2"x25 cm	25	3,560
1325IFDD30	1/2"x1/2"x30 cm	25	3,784
1325IFDD35	1/2"x1/2"x35 cm	25	4,008
1325IFDD40	1/2"x1/2"x40 cm	25	4,228
1325IFDD50	1/2"x1/2"x50 cm	25	4,676



**Attacchi flessibili "MF" in treccia acciaio
inox, interno EPDM alimentare**
Flexible hose "MF" in stainless steel, internal
EPDM

cod.	misura	pz. x conf.	euro cad.
1325IMCC20	3/8"x3/8"x20 cm	25	3,072
1325IMCC25	3/8"x3/8"x25 cm	25	3,296
1325IMCC30	3/8"x3/8"x30 cm	25	3,516
1325IMCC35	3/8"x3/8"x35 cm	25	3,740
1325IMCC40	3/8"x3/8"x40 cm	25	3,964
1325IMCC50	3/8"x3/8"x50 cm	25	4,408
1325IMCD20	3/8"x1/2"x20 cm	25	3,236
1325IMCD25	3/8"x1/2"x25 cm	25	3,460
1325IMCD30	3/8"x1/2"x30 cm	25	3,684
1325IMCD35	3/8"x1/2"x35 cm	25	3,912
1325IMCD40	3/8"x1/2"x40 cm	25	4,136
1325IMCD50	3/8"x1/2"x50 cm	25	4,584
1325IMDC20	1/2"x3/8"x20 cm	25	3,560
1325IMDC25	1/2"x3/8"x25 cm	25	3,784
1325IMDC30	1/2"x3/8"x30 cm	25	4,008
1325IMDC35	1/2"x3/8"x35 cm	25	4,228
1325IMDC40	1/2"x3/8"x40 cm	25	4,452
1325IMDC50	1/2"x3/8"x50 cm	25	4,896
1325IMDD20	1/2"x1/2"x20 cm	25	3,784
1325IMDD25	1/2"x1/2"x25 cm	25	4,008
1325IMDD30	1/2"x1/2"x30 cm	25	4,228
1325IMDD35	1/2"x1/2"x35 cm	25	4,452
1325IMDD40	1/2"x1/2"x40 cm	25	4,676
1325IMDD50	1/2"x1/2"x50 cm	25	5,120



Attacchi flessibili in treccia acciaio inox, interno EPDM alimentare con ogiva Ø 10 mm, maschio prolungato

Flexible hose in stainless steel, internal EPDM with ogive Ø 10 mm, extended male

cod.	misura	pz. x conf.	euro cad.
1325OICC20	3/8"x20 cm	25	3,428
1325OICC25	3/8"x25 cm	25	3,652
1325OICC30	3/8"x30 cm	25	3,872
1325OICC35	3/8"x35 cm	25	4,096
1325OICC40	3/8"x40 cm	25	4,320
1325OGID20	1/2"x20 cm	25	5,656
1325OGID25	1/2"x25 cm	25	5,876
1325OGID30	1/2"x30 cm	25	6,100
1325OGID35	1/2"x35 cm	25	6,320
1325OGID40	1/2"x40 cm	25	6,544



Attacchi flessibili "F" in treccia acciaio inox, interno EPDM alimentare e ogiva Ø 10 mm

Flexible hose "F" in stainless steel, internal EPDM, ogive Ø 10 mm

cod.	misura	pz. x conf.	euro cad.
1325OGIFC20	3/8"x20 cm	25	4,008
1325OGIFC25	3/8"x25 cm	25	4,228
1325OGIFC30	3/8"x30 cm	25	4,452
1325OGIFC35	3/8"x35 cm	25	4,676
1325OGIFC40	3/8"x40 cm	25	4,896
1325OGIFD20	1/2"x20 cm	25	5,032
1325OGIFD25	1/2"x25 cm	25	5,344
1325OGIFD30	1/2"x30 cm	25	5,656
1325OGIFD35	1/2"x35 cm	25	5,964
1325OGIFD40	1/2"x40 cm	25	6,276



Attacchi flessibili in treccia acciaio inox, interno EPDM alimentare, "MF" maschio prolungato

Flexible hose in stainless steel, internal EPDM with extended male, MF

cod.	misura MPxF	pz. x conf.	euro cad.
1326IMCC20	3/8"x3/8"x20 cm	25	3,472
1326IMCC25	3/8"x3/8"x25 cm	25	3,696
1326IMCC30	3/8"x3/8"x30 cm	25	3,916
1326IMCC35	3/8"x3/8"x35 cm	25	4,140
1326IMCC40	3/8"x3/8"x40 cm	25	4,364
1326IMCC50	3/8"x3/8"x50 cm	25	4,808
1326IMCD20	3/8"x1/2"x20 cm	25	3,696
1326IMCD25	3/8"x1/2"x25 cm	25	3,916
1326IMCD30	3/8"x1/2"x30 cm	25	4,140
1326IMCD35	3/8"x1/2"x35 cm	25	4,364
1326IMCD40	3/8"x1/2"x40 cm	25	4,584
1326IMCD50	3/8"x1/2"x50 cm	25	5,032
1326IMDC20	1/2"x3/8"x20 cm	25	4,320
1326IMDC25	1/2"x3/8"x25 cm	25	4,540
1326IMDC30	1/2"x3/8"x30 cm	25	4,764
1326IMDC35	1/2"x3/8"x35 cm	25	4,988
1326IMDC40	1/2"x3/8"x40 cm	25	5,208
1326IMDC50	1/2"x3/8"x50 cm	25	5,656
1326IMDD20	1/2"x1/2"x20 cm	25	4,584
1326IMDD25	1/2"x1/2"x25 cm	25	4,808
1326IMDD30	1/2"x1/2"x30 cm	25	5,032
1326IMDD35	1/2"x1/2"x35 cm	25	5,252
1326IMDD40	1/2"x1/2"x40 cm	25	5,476
1326IMDD50	1/2"x1/2"x50 cm	25	5,920



Attacchi flessibili per monocomando in treccia acciaio inox F e M 10x1, interno EPDM alimentare

Flexible hose in stainless steel, internal EPDM, male M10x1 female

cod.	misura	pz. x conf.	euro cad.
1325MFNC30	3/8"x30 cm	25	3,148
1325MFNC35	3/8"x35 cm	25	3,372
1325MFNC40	3/8"x40 cm	25	3,596
1325MFNC50	3/8"x50 cm	25	4,044
1325MFND30	1/2"x30 cm	25	3,372
1325MFND35	1/2"x35 cm	25	3,596
1325MFND40	1/2"x40 cm	25	3,820
1325MFND50	1/2"x50 cm	25	4,268



Flessibile antivibrante MF

Anti-vibration flexible hose MF

cod.	misura	pz. x conf.	euro cad.
1329MFDD30	1/2"x1/2"x30 cm	5	5,336
1329MFDD40	1/2"x1/2"x40 cm	5	5,880
1329MFDD50	1/2"x1/2"x50 cm	5	6,428
1329MFDD60	1/2"x1/2"x60 cm	1	7,016
1329MFDD80	1/2"x1/2"x80 cm	1	8,192
1329MFD100	1/2"x1/2"x100 cm	1	9,324
1329MFD150	1/2"x1/2"x150 cm	1	12,432
1329MFFF30	3/4"x3/4"x30 cm	5	8,064
1329MFFF40	3/4"x3/4"x40 cm	5	8,948
1329MFFF50	3/4"x3/4"x50 cm	5	9,872
1329MFFF60	3/4"x3/4"x60 cm	1	10,668
1329MFFF80	3/4"x3/4"x80 cm	1	12,432
1329MFF100	3/4"x3/4"x100 cm	1	14,156
1329MFF150	3/4"x3/4"x150 cm	1	18,984
1329MFGG30	1"x1"x30 cm	5	11,216
1329MFGG40	1"x1"x40 cm	5	12,476
1329MFGG50	1"x1"x50 cm	5	13,736
1329MFGG60	1"x1"x60 cm	1	14,912
1329MFGG80	1"x1"x80 cm	1	17,388
1329MFG100	1"x1"x100 cm	1	19,908
1329MFG150	1"x1"x150 cm	1	26,672
1329MFGB30	1"1/4"x1"1/4"x30 cm	5	22,892
1329MFGB40	1"1/4"x1"1/4"x40 cm	5	24,780
1329MFGB50	1"1/4"x1"1/4"x50 cm	5	26,588
1329MFGB60	1"1/4"x1"1/4"x60 cm	1	28,392
1329MFGB80	1"1/4"x1"1/4"x80 cm	1	32,132
1329MFGB10	1"1/4"x1"1/4"x100 cm	1	35,868
1329MFGB15	1"1/4"x1"1/4"x150 cm	1	45,572
1329MFGD30	1"1/2"x1"1/2"x30 cm	5	32,760
1329MFGD40	1"1/2"x1"1/2"x40 cm	5	35,364
1329MFGD50	1"1/2"x1"1/2"x50 cm	5	38,012
1329MFGD60	1"1/2"x1"1/2"x60 cm	1	40,532
1329MFGD80	1"1/2"x1"1/2"x80 cm	1	45,780
1329MFGD10	1"1/2"x1"1/2"x100 cm	1	51,032
1329MFGD15	1"1/2"x1"1/2"x150 cm	1	65,520
1329MFHH30	2"x2"x30 cm	5	51,032
1329MFHH40	2"x2"x40 cm	5	54,432
1329MFHH50	2"x2"x50 cm	5	57,920
1329MFHH60	2"x2"x60 cm	1	61,404
1329MFHH80	2"x2"x80 cm	1	68,292
1329MFH100	2"x2"x100 cm	1	75,264
1329MFH150	2"x2"x150 cm	1	93,452



Raccordo flessibile estensibile UNI 11353 con protezione esterna ignifuga-atossica MF

Extendible-flexible hose connection UNI 11353
with external atoxic-fire retardant
protection MF

cod.	misura	pz. x conf.	euro cad.
3012NMFDD1	1/2"x1/2" 65-125 mm	12	10,900
3012NMFDD2	1/2"x1/2" 100-200 mm	12	11,416
3012NMFDD3	1/2"x1/2" 200-400 mm	12	12,904
3012NMFDF1	1/2"x3/4" 65-125 mm	12	16,796
3012NMFDF2	1/2"x3/4" 100-200 mm	12	17,480
3012NMFDF3	1/2"x3/4" 200-400 mm	12	20,184
3012NMFFF1	3/4"x3/4" 65-125 mm	12	16,796
3012NMFFF2	3/4"x3/4" 100-200 mm	12	17,480
3012NMFFF3	3/4"x3/4" 200-400 mm	12	20,184



Raccordo flessibile in acciaio inox per gas conforme alla UNI EN 14800

Flexible inox s/steel connection complying with
UNI EN 14800

cod.	misura	pz. x conf.	euro cad.
5029NTM100	1/2"x1/2" L 1000	12	34,916
5029NTM150	1/2"x1/2" L 1500	12	39,804
5029NTM200	1/2"x1/2" L 2000	12	44,564



Raccordo flessibile estensibile UNI EN 14800 con protezione esterna ignifuga-atossica FF

Extendible-flexible hose connection UNI EN 14800
with external atoxic-fire retardant protection FF

cod.	misura	pz. x conf.	euro cad.
5029NTF100	1/2"x1/2" L 1000	12	32,816
5029NTF150	1/2"x1/2" L 1500	12	37,704
5029NTF200	1/2"x1/2" L 2000	12	42,464



Giunto in ottone cromato con adattatori in gomma per gas metano o liquido

Chrome plated brass connection with rubber adapters for natural or liquid gas

cod.	pz. x conf.	euro cad.
5029G00000	10	3,640



Gomito in ottone maschio - maschio

Brass MM elbow

cod.	misura	pz. x conf.	euro cad.
5029OTMMD	1/2" pass.int. Ø 13	10	1,736
5029OTMMF	3/4" pass.int. Ø 19	10	1,736



Gomito in ottone maschio - femmina

Brass MF elbow

cod.	misura	pz. x conf.	euro cad.
5029OTMFD	MF1/2" pass.int. Ø 13	10	2,128



Rubinetto in ottone sbiancato per gas

Nichel plated valve for gas

cod.	misura	pz. x conf.	euro cad.
1500NTMDD	MM 1/2"x1/2"	20	12,000
1500NTMFD	MF 1/2"x1/2"	20	12,000



Rubinetto in ottone sbiancato per gas con girello

Roating nichel plated valve for gas

cod.	misura	pz. x conf.	euro cad.
1500NTGMDD	MF 1/2"x1/2"	20	12,080
1500NTGFDD	FF 1/2"x1/2"	20	12,080



Raccordo portagomma metano diritto in ottone nudo - femmina

Yellow brass straight hose connection F for natural gas

cod.	misura	pz. x conf.	euro cad.
139200000C	F 3/8"	10	1,984
139200000D	F 1/2"	10	2,432



Raccordo portagomma metano diritto in ottone cromato - femmina

Chromed plated brass straight hose connection F for natural gas

cod.	misura	pz. x conf.	euro cad.
13920C000C	F 3/8"	10	2,184
13920C000D	F 1/2"	10	2,604



Raccordo portagomma metano in ottone nudo tipo diritto - maschio

Yellow brass straight hose connection for natural gas M

cod.	misura	pz. x conf.	euro cad.
139400000C	M 3/8"	10	1,736
139400000D	M 1/2"	10	2,108



Raccordo portagomma metano ottone cromato tipo diritto - maschio

Chromed plated brass straight hose connection M for natural gas

cod.	misura	pz. x conf.	euro cad.
13940C000C	M 3/8"	10	1,936
13940C000D	M 1/2"	10	2,308



Raccordo portagomma metano in ottone nudo tipo curvo - femmina

Yellow brass bended hose connection F for natural gas

cod.	misura	pz. x conf.	euro cad.
139300000C	F 3/8"	10	3,472
139300000D	F 1/2"	10	3,348



**Raccordo portagomma metano
in ottone cromato tipo curvo - femmina**

Chrome brass bended hose
connection F for natural gas

cod.	misura	pz. x conf.	euro cad.
13930C000C	F 3/8"	10	3,720
13930C000D	F 1/2"	10	3,596



**Raccordo portagomma metano
in ottone nudo tipo curvo - maschio**

Yellow brass bended hose
connection M for natural gas

cod.	misura	pz. x conf.	euro cad.
139500000C	M 3/8"	10	3,720
139500000D	M 1/2"	10	4,216



**Raccordo portagomma metano
in ottone cromato tipo curvo - maschio**

Chromed brass bended hose
connection M for natural gas

cod.	misura	pz. x conf.	euro cad.
13950C000C	M 3/8"	10	3,968
13950C000D	M 1/2"	10	4,464



**Raccordo portagomma GPL
in ottone nudo tipo diritto - femmina**

GPL yellow brass straight hose
connection F

cod.	misura	pz. x conf.	euro cad.
139600000C	F 3/8"	10	1,984
139600000D	F 1/2"	10	2,432



**Raccordo portagomma GPL
in ottone cromato tipo diritto - femmina**

GPL chrome plated brass
straight hose connection F

cod.	misura	pz. x conf.	euro cad.
13960C000C	F 3/8"	10	2,184
13960C000D	F 1/2"	10	2,604



**Raccordo portagomma GPL
in ottone nudo tipo diritto - maschio**

GPL yellow brass straight
hose connection M

cod.	misura	pz. x conf.	euro cad.
139800000C	M 3/8"	10	1,736
139800000D	M 1/2"	10	2,108



**Raccordo portagomma GPL
in ottone cromato tipo diritto - maschio**

GPL chrome plated brass straight
hose connection M

cod.	misura	pz. x conf.	euro cad.
13980C000C	M 3/8"	10	1,936
13980C000D	M 1/2"	10	2,308



**Raccordo portagomma GPL
in ottone nudo tipo curvo - femmina**

GPL yellow brass bended
hose connection F

cod.	misura	pz. x conf.	euro cad.
139700000C	F 3/8"	100	3,596
139700000D	F 1/2"	100	3,472



**Raccordo portagomma GPL
in ottone cromato tipo curvo - femmina**

GPL chrome plated brass bended
hose connection F

cod.	misura	pz. x conf.	euro cad.
13970C000C	F 3/8"	100	3,844
13970C000D	F 1/2"	100	3,720



**Raccordo portagomma GPL
in ottone nudo tipo curvo - maschio**

GPL yellow brass bended
hose connection M

cod.	misura	pz. x conf.	euro cad.
139900000C	M 3/8"	10	3,844
139900000D	M 1/2"	10	4,340



**Raccordo portagomma GPL
in ottone cromato tipo curvo - maschio**

GPL chrome plated brass bended
hose connection M

cod.	misura	pz. x conf.	euro cad.
13990C000C	M 3/8"	10	4,092
13990C000D	M 1/2"	10	4,588



**Raccordo portagomma
tipo diritto in ottone cromato**

Chrome plated brass straight
hose connection

cod.	misura	pz. x conf.	euro cad.
6014M0000D	M 1/2" Ø 14 mm	10	0,996
6014F0000D	F 1/2" Ø 14 mm	10	1,800



**Raccordo portagomma
in ottone cromato tipo diritto**

Chrome plated brass straight
connection

cod.	misura	pz. x conf.	euro cad.
1398L00000	M 1/2" Ø 9 mm	10	0,688
1396L00000	F 1/2" Ø 9 mm	10	0,728



**Tubo gas metano in PVC con inserzione
tessile a norma UNI-CIG 7140 e marchio
IMQ**

PVC tube for natural gas
UNI-CIG and IMQ Standard rules

cod.	misura	mt x conf.	euro mt
1387000000	Ø 20x13 mm	50	1,780



**Tubo gas liquido in PVC con inserzione
tessile a norma UNI-CIG 7140 e marchio
IMQ**

PVC tube for liquid gas
UNI-CIG and IMQ Standard rules

cod.	misura	mt x conf.	euro mt
1389000000	Ø 13x8 mm	50	0,892



**Guaina estensibile-comprimibile "Yellowfless"
in PP autoestinguente classe "UL 94 V.0"
a norme UNI-CIG 7129**

Extensible and compressible PP "Yellowfless"
"UL 94 V.0" UNI-CIG 7129
standard rule-self extinguisher

cod.	misura	mt x conf.	euro mt
1924310020	Ø 20 mm	50	0,756
1924310025	Ø 25 mm	50	0,920
1924310030	Ø 30 mm	50	1,106
1924310040	Ø 40 mm	50	1,892





Guaina flessibile spiralata in materiale plastico autoestinguente classe "UL 94 V.O" per rivestimento tubi rame

Flexible plastic material for copper tube "UL 94 V.O" self extinguisher

cod.	misura	mt x conf.	euro mt
1555500020	Ø 20 mm	25	0,912
1555500025	Ø 25 mm	25	1,184
1555500030	Ø 30 mm	25	1,556
1555500035	Ø 35 mm	25	1,884
1555500040	Ø 40 mm	25	2,312
1555500050	Ø 50 mm	25	3,008
1555500060	Ø 60 mm	25	3,620



Rotolo tubo scarico condensa

Roll pipe for condensate drainage

cod.	misura	mt x conf.	euro mt
1555700016	Ø 16 mm	25	0,848
1555700018	Ø 18 mm	25	0,892
1555700020	Ø 20 mm	25	0,932

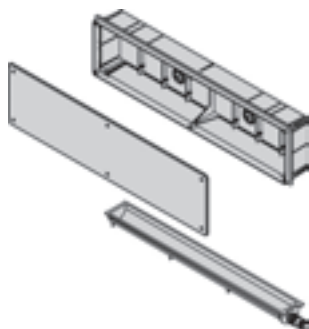

Cassetta da incasso per impianti condizionamento

Inlet box for conditioning plants

cod.	misura	pz. x conf.	euro cad.
1214CAS000	485x130x65	1	11,600



Mensola di sostegno con staffa e traversa

Wall bracket with traverse

cod.	misura	pz. x conf.	euro cad.
1214SC0080	80 kg	1	21,200
1214SC0150	150 kg	1	24,800

SERIE MISCELATORI ED ACCESSORI PER DOCCIA E BAGNO

MIXERS AND ACCESSORIES FOR SHOWER AND BATH

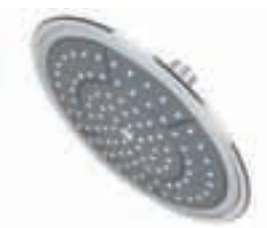

Soffione "Round" cromato

Chromed "Round" shower head

new

cod.	misura	pz. x conf.	euro cad.
KS21500000	Ø 150 mm	10	10,222
KS22000000	Ø 200 mm	10	13,333



Soffione "Class" cromato

Chromed "Class" shower head

new

cod.	misura	pz. x conf.	euro cad.
KS31500000	Ø 150 mm	10	7,111
KS32000000	Ø 200 mm	10	11,556



Soffione cromato quadrato

Chromed quadrate shower head

new

cod.	misura	pz. x conf.	euro cad.
KQUADRO000	200x200 mm	10	17,778



Soffione "Style" cromato

Chromed "Style" shower head

new

cod.	pz. x conf.	euro cad.
KS10000000	10	17,778



Soffione cromato "One Jet" a 1 funzione

Chrome plated shower head "One Jet" 1 function

cod.	pz. x conf.	euro cad.
MGS-----	10	4,000



Soffione cromato "Three Jet" a 3 funzioni

Chrome plated shower head "Three Jet" 3 functions

cod.	pz. x conf.	euro cad.
TGS-----	10	5,778



Soffione cromato "Jet Set" a 5 funzioni

Chrome plated shower head "Jet Set" 5 functions

cod.	pz. x conf.	euro cad.
VBS-----	10	10,000



Soffione doccia "Perfecta" in ottone cromato con snodo

Chrome plated brass shower head "Perfecta" with joint and connection F

cod.	misura	pz. x conf.	euro cad.
1420000000	F 1/2"	10	27,400





Soffione doccia ottone cromato "Mini Perfecta" con snodo attacco F
 Chrome plated brass shower head "Mini Perfecta" with joint and connection F

cod.	misura	pz. x conf.	euro cad.
1421000000	1/2"	10	22,280



Soffione in ottone cromato con getto regolabile
 Chrome plated brass shower head with adjustable jet

cod.	pz. x conf.	euro cad.
1419000000	10	11,111



Soffione tipo americano con snodo
 American version of shower head with joint

cod.	pz. x conf.	euro cad.
1422000000	10	11,000



Soffione doccia a campana in ottone cromato con snodo
 Chrome plated brass cone shower head with joint

cod.	pz. x conf.	euro cad.
5043SN0000	10	7,763



Asta doccia con soffione attacco 3/4"
 Shower bar with shower head connection 3/4"

cod.	pz. x conf.	euro cad.
5043ASTADO	1	5,867



Soffione doccia lastra inox Ø 100
 Stainless steel plate shower head Ø 100

cod.	pz. x conf.	euro cad.
5043LAS100	1	2,222



Braccio doccia in ottone cromato tipo pesante
 Chrome plated brass shower arm, heavy type

cod.	pz. x conf.	euro cad.
1427000000	10	38,640
1427ECO000 "ECO"	10	17,000



Braccio doccia in ottone cromato
 Chrome plated brass shower-arm

cod.	misura	pz. x conf.	euro cad.
5042000200	200mm	10	6,422
5042000250	250mm	10	7,486
5042000300	300mm	10	7,803



Braccio doccia cromato inclinato
 Sloping chromed shower arm

cod.	misura	pz. x conf.	euro cad.
5042INCL00	18x200 mm	10	4,784
5042INCL25	18x250 mm	10	5,652
5042INCL30	18x300 mm	10	6,088



Set doccia lux "Queen" con miscelatore
 "Queen" full lux shower set with mixer

cod.	pz. x conf.	euro cad.
Q000000000	1	200,000



Set doccia lux "Queen" s/miscelatore
 "Queen" lux shower set without mixer

cod.	pz. x conf.	euro cad.
Q001000000	1	152,000



Saliscendi cromato "One Jet"
 con doccia a 1 funzione, portasapone
 e flessibile cromato lunghezza 150cm
 Chrome plated brass sliding rail set "One Jet"
 with shower 1 function, soap holder
 and chromed flexible length 150cm

cod.	pz. x conf.	euro cad.
MG-----	10	24,444



Doccetta cromata "One Jet"
 a 1 funzione

Chrome plated hand shower "One Jet"
 with 1 function

cod.	pz. x conf.	euro cad.
MGD-----	25	3,111



Saliscendi cromato "Three Jet"
 con doccia a 3 funzioni regolabili,
 portasapone e flessibile cromato lunghezza
 150cm

Chrome plated brass sliding rail set "Three Jet"
 with 3 adjustable shower functions, soap holder
 and chromed flexible length 150cm

cod.	pz. x conf.	euro cad.
TG-----	10	24,750



Doccetta cromata "Three Jet"
 a 3 funzioni

Chrome plated hand shower "Three Jet"
 with 3 functions

cod.	pz. x conf.	euro cad.
TGD-----	25	6,222



Saliscendi cromato "Five Jet" con doccia a 5 funzioni regolabili, portasapone e flessibile cromato lunghezza 150cm

Chrome plated brass sliding rail set "Five Jet" with shower 5 adjustable functions, soap holder and chrome flexible length 150cm

cod.	pz. x conf.	euro cad.
FIVEJ-----	10	28,350



Saliscendi cromato "Jet Set" con doccia a 5 funzioni regolabili, portasapone e flessibile in acciaio inox lunghezza 150cm

Chrome plated brass sliding rail set "Jet Set" with shower 5 adjustable functions, soap holder and stainless steel flexible length 150cm

cod.	pz. x conf.	euro cad.
VB-----	10	28,350



Doccetta cromata "Five Jet" a 5 funzioni

Chrome plated hand shower "Five Jet" with 5 functions

cod.	pz. x conf.	euro cad.
FIVEJD----	10	10,222



Doccetta cromata "Jet Set" a 5 funzioni

Chrome plated hand shower "Jet Set" with 5 functions

cod.	pz. x conf.	euro cad.
VBD-----	10	9,258



Doccetta "King" cromata King chromed hand shower

cod.	misura	pz. x conf.	euro cad.
KD00000000	142mm	10	17,778



new

Saliscendi cromato con doccia a 1 funzione, portasapone e flessibile cromato lunghezza 150cm

Chromed sliding rail set with hand shower 1 function, soap holder and chromed flexible length 150cm

cod.	pz. x conf.	euro cad.
K100000000	1	31,111



new

Doccetta cromata "King 1" a 1 funzione

Chrome plated hand shower 1 function

cod.	pz. x conf.	euro cad.
KD10000000	10	7,044



new

Saliscendi cromato con doccia a 3 funzioni regolabili, portasapone e flessibile cromato lunghezza 150cm

Chromed sliding rail set with hand shower 3 adjustable functions, soap holder and chromed flexible length 150cm

cod.	pz. x conf.	euro cad.
K300000000	1	35,111



new

Doccetta cromata "King 3" a 3 funzioni

Chrome plated hand shower 3 functions

cod.	pz. x conf.	euro cad.
KD30000000	10	8,000





new

Saliscendi cromato con doccia a 4 funzioni regolabili, portasapone e flessibile cromato lunghezza 150cm

Chromed sliding rail set with hand shower 4 adjustable functions, soap holder and chromed flexible length 150cm

cod.	pz. x conf.	euro cad.
K400000000	1	33,778



new

Doccetta cromata "King 4" a 4 funzioni

Chrome plated hand shower 4 functions

cod.	pz. x conf.	euro cad.
KD40000000	10	6,667



Set doccia "Queen"

"Queen" shower set

cod.	pz. x conf.	euro cad.
QONE000000	1	32,000



Doccetta cromata "queen"

Queen chromed hand shower

cod.	pz. x conf.	euro cad.
QONED00000	10	13,333



Doccetta classica
Classic hand shower

cod.		pz. x conf.	euro cad.
143100000B	bianca	10	6,200
143100000N	nera	10	6,200



Doccetta classica con attacco inclinato per duplex

Classic hand shower with duplex slanting connection

cod.		pz. x conf.	euro cad.
143400000B	bianca	5	7,800
143400000N	nera	5	7,800



Doccetta lavello "Space" cromata con inversione di getto a ritorno automatico
Sink chrome plated hand shower "Space" with automatic backflow jet reversal

cod.		pz. x conf.	euro cad.
6605NT0000		10	8,000



Forcella a muro in ottone cromato con snodo esterno e attacco conico per doccetta duplex
Chrome plated brass wall fork with external joint and conical connection for duplex hand shower

cod.		pz. x conf.	euro cad.
1447CON000		10	12,800
1447CONECO		10	5,778



Forcella a muro in ottone cromato con snodo esterno per doccetta duplex
Chrome plated brass wall fork with external joint for duplex hand shower

cod.		pz. x conf.	euro cad.
1447000000		10	10,000



Supporto doccia a muro
Wall shower support

cod.		pz. x conf.	euro cad.
1447SUP000		10	2,222





Cursore saliscendi cromato

Chromed sliding holder

cod.	pz. x conf.	euro cad.
VBCUR-----	10	3,500
KCUR-----	10	4,444



Supporto per asta saliscendi

Sliding rail support

cod.	pz. x conf.	euro cad.
VBSPP-----	10	2,500



Flessibile doccia in ottone cromato FF 1/2"x1/2"

Chrome plated brass flexible shower
FF 1/2"x1/2"

cod.	misura	pz. x conf.	euro cad.
1449000120	120 cm	10	10,000
1449000150	150 cm	10	10,600
1449000200	200 cm	10	14,080



Flessibile doccia in ottone cromato con attacco conico FF 1/2"x1/2"

Chrome plated brass flexible shower
with conic connection FF 1/2"x1/2"

cod.	misura	pz. x conf.	euro cad.
1449C00120	120 cm	10	10,800
1449C00150	150 cm	10	11,480
1449C00200	200 cm	10	15,000



Flessibile doccia conico in ottone cromato doppia graffatura F 1/2"x1/2"

Chrome plated brass conic flexible shower
with double grip F 1/2"x1/2"

cod.	misura	pz. x conf.	euro cad.
1449C0DA150	150 cm	10	15,583
1449C0DA200	200 cm	10	20,900



Flessibile doccia cromato

Chrome shower flexible

cod.	misura	pz. x conf.	euro cad.
1449CX0150	150 cm	10	3,600
1449CX0200	200 cm	10	4,400



**Flessibile doccia estensibile
in acciaio inox attacco conico F1/2"xF1/2"**

Extensible stainless steel flexible shower and
conic connection F1/2"xF1/2"

cod.	misura	pz. x conf.	euro cad.
1449INOX150	150 cm	10	6,222
1449INOX200	200 cm	10	8,000



**Flessibile doccia
conico in ottone cromato M15/1xF1/2"**

Shower chrome plated brass conic flexible
M15/1xF1/2"

cod.	misura	pz. x conf.	euro cad.
1450PCD120	120 cm	10	14,600
1450PCD150	150 cm	10	15,600
1450PCD200	200 cm	10	19,600



**Flessibile doccia
in ottone cromato M15/1**

Shower chrome plated brass flexible M15/1

cod.	misura	pz. x conf.	euro cad.
1450PDD120	F1/2"	10	14,320
1450PDD150	F1/2"	10	15,520
1450PDO120	F3/8"	10	13,400
1450PDO150	F3/8"	10	15,800



MISCELATORI
MIXERS

SERIE "PRINCE"



SERIE "PRINCE"



Miscelatore monocomando per lavabo con scarico saltarello in ottone 1"1/4

Wash basin single lever mixer with brass pop-up drain 1"1/4

cod.	pz. x conf.	euro cad.
P100CR00GB	12	36,500



Miscelatore monocomando per bidet con scarico saltarello in ottone 1"1/4

Bidet single lever mixer with brass pop-up drain 1"1/4

cod.	pz. x conf.	euro cad.
P101CR00GB	12	36,500



Miscelatore monocomando per vasca esterno con doccia duplex e flessibile 150 cm

Bath single external lever mixer with shower duplex and flexible 150 cm

cod.	pz. x conf.	euro cad.
P102CR0000	12	45,000



Deviatore per mix vasca Prince

Switch for bath Prince faucet

cod.	pz. x conf.	euro cad.
PDEV000000	10	3,556



Miscelatore monocomando da incasso per doccia

Built in single lever shower mixer

cod.	pz. x conf.	euro cad.
P103CR0000	16	25,000





Miscelatore monocomando esterno per doccia

External shower single lever mixer

cod.	pz. x conf.	euro cad.
P104CR0000	12	38,000



Miscelatore monocomando per lavello a parete con bocca girevole

Wall single lever sink mixer with swivel spout

cod.	pz. x conf.	euro cad.
P105CR0000	12	36,500



Miscelatore monocomando per lavello con bocca alta girevole

Single lever sink mixer with swivel spout

cod.	pz. x conf.	euro cad.
P106CR0000	12	36,000



Miscelatore monocomando per lavello con bocca girevole

Single lever sink mixer with cast swivel spout

cod.	pz. x conf.	euro cad.
P107CR0000	12	32,000

SERIE "PRINCE"



Miscelatore monocomando per lavello con canna girevole e doccetta estraibile

Wall single lever mixer with swivel spout and extractible hand shower

cod.	pz. x conf.	euro cad.
E508CR0000	12	65,000



Leva monocomando serie "Prince"

Single mixer lever "Prince" series

cod.	pz. x conf.	euro cad.
P10MAN0000	10	3,500



Leva clinica per miscelatori

Mixer clinical lever

cod.	pz. x conf.	euro cad.
G200LEVACL	10	8,889

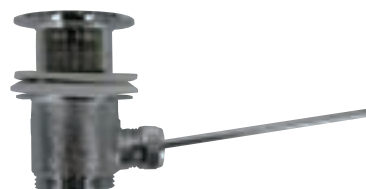

Piletta di scarico

Drain valve

cod.	misura	pz. x conf.	euro cad.
P10PIL000G	1"	10	10,000
P10PIL0000	1"1/4	10	11,200

SERIE "PRINCE"



Saltarello serie "Prince"

Ratchet "Prince" serie

cod.	pz. x conf.	euro cad.
P10SALT000	10	1,000



Cartuccia per miscelatore monocomando

Cartridge for single lever mixer

cod.	misura	pz. x conf.	euro cad.
PC00000000	Ø 40 mm	10	4,250
QC00000000	Ø 35 mm	10	4,150



SERIE "KING"
"KING" SERIE



SERIE "KING"



Miscelatore "King" monocomando per lavabo con scarico saltarello in ottone 1"1/4

Wash basin "King" single lever mixer with brass pop-up drain 1"1/4

cod.	pz. x conf.	euro cad.
K100CR00GB	12	72,000



Miscelatore "King" monocomando per bidet con scarico saltarello in ottone 1"1/4

Bidet single "King" lever mixer with brass pop-up drain 1"1/4

cod.	pz. x conf.	euro cad.
K101CR00GB	12	72,000



Miscelatore "King" monocomando per vasca esterno con doccia duplex e flessibile 150cm

Bath single "King" external lever mixer with shower duplex and flexible 150cm

cod.	pz. x conf.	euro cad.
K102CR0000	12	88,000



Deviatore per mix vasca King

Switch for bath King faucet

cod.	pz. x conf.	euro cad.
KDEV000000	12	7,556



Miscelatore "King" monocomando incasso per doccia

Built in single lever "King" shower mixer

cod.	pz. x conf.	euro cad.
K103CR0000	12	44,000



Miscelatore "King" monocomando esterno per doccia

External shower "King" single lever mixer

cod.	pz. x conf.	euro cad.
K104CR0000	12	60,000





Miscelatore "King" monocomando per lavello a parete con bocca girevole

Wall single lever sink mixer "King" with swivel spout

cod.	pz. x conf.	euro cad.
K105CR0000	12	68,000



Miscelatore "King" monocomando per lavello con bocca alta girevole

Single lever sink mixer "King" with swivel spout

cod.	pz. x conf.	euro cad.
K106CR0000	1	56,000



Miscelatore "King" lavello canna alta girevole angolo retto

Single lever sink mixer "King" with swivel spout

cod.	pz. x conf.	euro cad.
K110CR0000	12	56,000



Miscelatore "King" monocomando per lavello con bocca girevole

Single lever sink mixer "King" with cast swivel spout

cod.	pz. x conf.	euro cad.
K107CR0000	12	44,000



SERIE "QUEEN"
"QUEEN" SERIE





Miscelatore "queen" monocomando per lavabo con scarico saltarello in ottone 1"1/4

Wash basin "queen" single lever mixer with brass pop-up drain 1"1/4

cod.	pz. x conf.	euro cad.
Q100CR00GB	12	72,000



Miscelatore "queen" monocomando per bidet con scarico saltarello in ottone 1"1/4

Bidet single "queen" lever mixer with brass pop-up drain 1"1/4

cod.	pz. x conf.	euro cad.
Q101CR00GB	12	72,000



Miscelatore "queen" monocomando per vasca esterno con doccia duplex e flessibile 150cm

Bath single "queen" external lever mixer with shower duplex and flexible 150cm

cod.	pz. x conf.	euro cad.
Q102CR0000	12	100,000



Deviatore per mix vasca "queen"

Switch for bath "Queen" faucet

cod.	pz. x conf.	euro cad.
QDEV000000	10	4,444



Miscelatore "Queen" monocomando da incasso per doccia

Built in single lever shower mixer "queen"

cod.	pz. x conf.	euro cad.
Q103CR0000	12	40,000



Miscelatore "Queen" monocomando esterno per doccia

External shower "queen" single lever mixer

cod.	pz. x conf.	euro cad.
Q104CR0000	12	68,000

SERIE "QUEEN"



Miscelatore "Queen" monocomando per lavello con bocca alta girevole

Single lever sink mixer "queen" with swivel spout

cod.	pz. x conf.	euro cad.
Q106CR0000	12	80,000



Miscelatore "Queen" monocomando per lavello con canna girevole e doccetta estraibile

Single lever sink mixer "Queen" with swivel spout and extractible hand-shower

cod.	pz. x conf.	euro cad.
Q108CR0000	12	116,000



Miscelatore "Queen" monocomando per lavabo a testa cieca

Wash basin single lever "Queen" mixer

cod.	pz. x conf.	euro cad.
Q109CR00GB	12	116,000

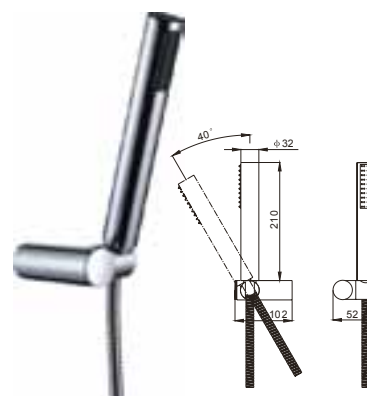

Supporto in plastica con rosone per doccetta "Queen"

Plastic support with rosette for "Queen" hand shower

cod.	pz. x conf.	euro cad.
QSUPP00001	12	12,000

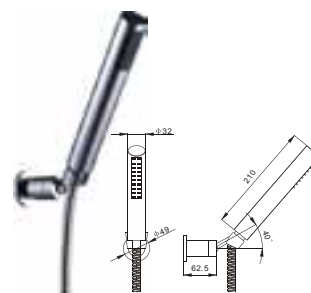

Supporto in plastica per doccetta "Queen"

Plastic support for "Queen" hand shower

cod.	pz. x conf.	euro cad.
QSUPP00002	12	15,800

**ACCESSORI BAGNO
IN OTTONE E VETRO
ACIDATO**

**BATH ACCESSORIES
IN BRASS AND ACIDATED
GLASS**



Porta sapone
Soap holder

cod.	pz. x conf.	euro cad.
ONE0000744	6	16,335



Porta bicchiere
Glass holder

cod.	pz. x conf.	euro cad.
ONE0000745	6	16,335



Mensola
Bracket

cod.	pz. x conf.	euro cad.
ONE0000746	4	43,065



Porta asciugamani
Towel holder

cod.	misura	pz. x conf.	euro cad.
ONE0000747	30 cm	6	23,018



Porta asciugamani
Towel holder

cod.	misura	pz. x conf.	euro cad.
ONE0000748	56 cm	6	24,503



Porta asciugamani anello
Ring towel holder

cod.	pz. x conf.	euro cad.
ONE0000749	6	20,790



Porta rotolo aperto

Open toilet paper holder

cod.	pz. x conf.	euro cad.
ONE0000751	6	17,820



Appendiabiti

Bathcloth-hanger

cod.	pz. x conf.	euro cad.
ONE0000753	12	13,365



Porta scopino

WC brush holder

cod.	pz. x conf.	euro cad.
ONE0000755	6	41,168



"One Kit"

"One Kit"

cod.	pz. x conf.	euro cad.
ONEKIT0000	serie 8 pezzi 6	111,375



ACCESSORI PER LA SICUREZZA IN BAGNO

BATH-ROOM SECURITY FITTINGS



Maniglione bianco

White shackle

cod.	misura	pz. x conf.	euro cad.
0091100001	35 cm	1	31,300
0091100002	45 cm	1	37,532
0091100003	60 cm	1	44,788
0091100004	75 cm	1	51,688
0091100005	90 cm	1	58,500
0091100006	120 cm	1	67,716

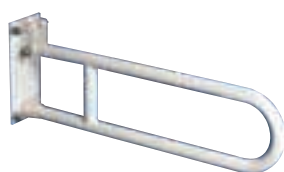

Barra di sostegno bianca ribaltabile

Overturning white support bar

cod.	misura	pz. x conf.	euro cad.
0091100007	65 cm	1	182,488
0091100008	85 cm	1	203,280

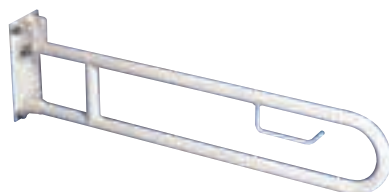

Barra di sostegno bianca ribaltabile con porta carta igienica

Overturning white support bar with toilet paper holder

cod.	misura	pz. x conf.	euro cad.
0091100009	85 cm	1	218,416



Corrimano verticale parete-pavimento bianco

White vertical wall to floor hand rail

cod.	misura	pz. x conf.	euro cad.
0091100010	180 cm	1	115,040

Corrimano verticale parete-parete bianco

White vertical wall to wall hand rail

cod.	misura	pz. x conf.	euro cad.
0091100011	180 cm	1	115,040



Sedile per vasca

Bath seat

cod.	pz. x conf.	euro cad.
0091100012	1	162,408



Sedile ribaltabile per doccia

Overturning shower seat

cod.	pz. x conf.	euro cad.
0091100013	1	226,032



Sedile ribaltabile per doccia con schienale

Overturning shower seat with seat back

cod.	pz. x conf.	euro cad.
0091100014	1	270,680



Sedile da appendere al corrimano

Seat to be hanged at handrail

cod.	pz. x conf.	euro cad.
0091100015	1	241,476



Specchio reclinabile

Inclinable mirror

cod.	pz. x conf.	euro cad.
0091100023	1	171,716



Copriwater "Easy Bid" - adattabile ad ogni WC

Seat cover "Easy Bid" - adaptable to any WC

cod.		pz. x conf.	euro cad.
AB1000AESY	mixer	1	140,000
AB2000AESY	rubinetti	1	120,000





Copriwater "Gabbiano" in PP
PP wc cover "Gabbiano"

cod.		pz. x conf.	euro cad.
AEB0000000	700 gr	10	6,168
AEB0000010	700 gr	15	5,200



Copriwater "Airone" in termoindurente
Thermoharden wc cover "Airone"

cod.		pz. x conf.	euro cad.
AB00000000	1300 gr	6	20,000



Copriwater "Fenice" in legno
Wood cover for wc "Fenice"

cod.		pz. x conf.	euro cad.
ABLEG00000		6	26,667



Coppia supporti wc in pvc con bulloni in ferro zincato

Pvc couple supports for wc with galvanized iron bolts

cod.		cp. x conf.	euro cp.
1121000000		25	0,708



Coppia supporti wc con bulloni in pvc

Couple supports for wc with pvc bolts

cod.		cp. x conf.	euro cp.
1122000000		25	0,548



Coppia cerniere universali cromate per wc
Universal chromed couple supports for wc

cod.		cp. x conf.	euro cp.
1456H00000		25	6,588



cod.		cp. x conf.	euro cp.
1456/ACC00		25	0,456





Paracolpo per copriwater

Wc cover bumper

cod.	pz. x conf.	euro cad.
501700000	100	0,143



cod.	pz. x conf.	euro cad.
501800000	100	0,109



cod.	pz. x conf.	euro cad.
501900000	100	0,067



cod.	pz. x conf.	euro cad.
5022DOP000	100	0,295



cod.	pz. x conf.	euro cad.
502300000	100	0,247



SIGILLANTI E PRODOTTI TERMICI

SEALERS AND THERMICAL PRODUCTS

Pasta verde 460 gr
Green paste 460 gr



cod.	pz. x conf.	euro cad.
148000000	48	2,435

Pasta verde "Locher" 400 gr
Green paste "Locher" 400 gr



cod.	pz. x conf.	euro cad.
1480LOC400	18	15,341

Pasta verde "Kolden" 400 gr
Green paste "Kolden" 400 gr



cod.	pz. x conf.	euro cad.
1480KOL400	30	5,864

Pasta verde "Extra Gas" 460 gr
Green paste "Extra Gas" 460 gr



cod.	pz. x conf.	euro cad.
1480EXGASO	60	3,640

Stucco nero per caldaia 950 gr
Black stopper for boiler 950 gr



cod.	pz. x conf.	euro cad.
148100000	24	8,400

Stucco bianco per uso sanitario 950 gr
White stopper for sanitary use 950 gr



cod.	pz. x conf.	euro cad.
148200000	24	4,920

Pasta saldante 130 gr
Welding paste 130 gr



cod.	pz. x conf.	euro cad.
148600000	40	2,680

Grasso per rubinetti
Grease for valves and faucets



cod.	pz. x conf.	euro cad.
1600/50/1-	100 gr	10
		2,320

Stearina in pani
Stearine in ingots



cod.	kg x conf.	euro al kg
148500000	1	6,400

**Fascia vinilica per avvolgimento
tubi h 100 mm x 25 mt**



Vinyl band for pipes 100 mm x 25 mt

cod.		pz. x conf.	euro a rotolo
1488B00000	bianca	70	4,840
1488R00000	rosso	70	4,840
1488BLU000	blu	70	4,840
1488V00000	verde	70	4,840
1488G00000	grigia	70	4,840



**Nastro polietilene per segnalazione
acqua, gas h 125 x L 200 mt**

Polyethylene strip for underground signal of
water, gas h 125 x L 200 mt

cod.		pz. x conf.	euro a rotolo
1490200000	acqua	10	13,600
1490300000	gas	10	13,600



**Nastro alluminio adesivo per giuntura
Adhesive aluminium tape for connection**

cod.	misura	pz. x conf.	euro a rotolo
0330200000	cm 5X50 ml	24	14,560
0330205X10	cm 5x10 ml	30	3,680
03302075X5	cm 7,5x5 ml	20	3,640
0330200075	cm 7,5x50 ml	16	19,920



**Nastro tela adesivo argento / nero / bianco
Cloth adhesive tape - silver / black / white**

cod.	misura	pz. x conf.	euro a rotolo
033020ARGE	argento cm5x50ml	24	9,760
033020NERO	nero cm5x50ml	24	9,760
033020BIAN	bianco cm5x50ml	24	9,760



**Fascia di isolamento "Densoflex"
Isolation bend "Densoflex"**

cod.	misura	pz. conf.	euro a rotolo
0430000000	50 mm x 10 mt	36	7,800
0430000050	100 mm x 10 mt	36	15,640



**Detergente schiumogeno per condizionatori
Conditioner frothing detergent**

cod.		pz. x conf.	euro cad.
1482DETCO		12	20,840



**Battericida, sanificante per condizionatori
Conditioner bactericide cleaning**

cod.		pz. x conf.	euro cad.
1482BATCO		12	27,600



**Lubrificante da ml 250 per tubi e raccordi a
bicchiere con anello**

Lubricant of 250ml for pipes and hopper connector with ring

cod.		pz. x conf.	euro cad.
1483LUBR00		50	3,760



**Antigelo puro
Pure antifreeze**

cod.		pz. x conf.	euro cad.
1481ANT012	12 Kg	1	5,240
1481ANT030	30 Kg	1	5,120
1481ANT230	230 Kg	1	5,000

**Antigelo Atossico
Atossic antifreeze**

cod.		pz. x conf.	euro cad.
1481ANT025	25 Kg	1	7,640





Fascia gomma adesiva classe 1

Rubber adhesive bend classe 1

cod.	misura	pz. x conf.	euro a rotolo.
1488GOMADE	cm 5x10 mt	50	6,040
	spess. 3mm		



Fascia anticondensa

Anti condensate bend

cod.	misura	pz. x conf.	euro a rotolo.
1488ACONDE	cm 5x9 mt	12	19,720
	spess. 3mm		



Verga in lega di stagno al 33%

Tin alloy rod 33%

cod.	kg x conf.	euro al kg
9000000033	1	38,120



Saldakit - Mastice bicomponente in astuccio da 60 gr

Saldakit bicomponent adhesive in case of 60 gr

cod.	pz. x conf.	euro cad.
6124000000	10	9,540



Mastice bianco in stick da 4 barrette L 500 mm

White compound adhesive in 4 stick L 500 mm

cod.	pz. x conf.	euro stick
9005000000	30	6,440



Cartuccia silicone antimuffa puro da 280 ml

Antimildew pure silicon cartridge of 280 ml

cod.		pz. x conf.	euro cad.
1489T00000	trasparente	30	5,168
1489B00000	bianco	30	5,284



Caricatore a pistola per cartuccia silicone

Silicone cartridge gun loader

cod.	pz. x conf.	euro cad.
1490000000	20	3,600



Rotolo nastro PTFE per tenuta filetti

PTFE teflon tape for threads

cod.	misura	pz. x conf.	euro cad.
1491R00000	12x10x0,076	250	0,288
1491000012	12x12x0,076	250	0,338
1491000F12	19x12x0,076	50	0,500
1491000G12	24x12x0,076	25	0,550



Rotolo nastro PTFE professionale per gas

Professional PTFE tape for gas

cod.	misura	pz. x conf.	euro cad.
1491SP0012	12x12x0,10	250	0,400



cod.	misura	pz. x conf.	euro cad.
1491T00000	19x15x0,20	50	1,556



Rotolo nastro teflon professionale per gas

Professional teflon tape for gas

cod.	misura	pz. x conf.	euro cad.
1491GAS000	Dupont 12x12x0,10	50	0,625



cod.	misura	pz. x conf.	euro cad.
1491P00000	Dupont 19x15x0,20	63	2,912
1491GAF012	Dupont 12x15x0,20	80	2,596



Rotolo nastro PTFE per vapore e alte temperature

PTFE teflon tape for vapour
and high pressure steam

cod.	misura	pz. x conf.	euro cad.
1491ROSA00	12x12x0,10	50	2,380



Sigillante anaerobico a base PTFE

Anaerobic PTFE dope

cod.		pz. x conf.	euro cad.
1491LIQ000	soffietto 75ml	12	6,760
1491LIQ075	flacone 75ml	12	6,760
1491LIQ100	flacone 100ml	12	11,480



Sigillante per filettature - filo sigillaraccordi e tubi

Wire-thread sealant for pipes and connectors

cod.		pz. x conf.	euro cad.
1491LOC000	rocchetto da 150ml		21,200



Sigillante super elastico in teflon universale per filetti resistente a temperature -200°C +280°C

Teflon universal thread sealant super elastic
temperature range -200°C +280°C

cod.	misura	pz. x conf.	euro cad.
1491SUPERD	50 mt	6	8,060



Canapa filata e pettinata Spinned and hacked hemp

cod.		conf.	euro al kg
1492000000	balla	50 kg	10,519
cod.		conf.	euro cad.
1492MAT000	matassa 250 gr	1	3,000
1492MAT125	matassa 125 gr	1	2,200
1492MAT060	matassa 60 gr	1	1,400

**Prezzo soggetto a variazioni di quotazione

Price subjected on different raw material quotation



Contenitore materiale plastico completo di rocchetto di canapa

Plastic container with hemp reel

cod.		pz x conf.	euro al Kg
1492CRO000	rocchetta + contenitore	10	2,800
1492ROC000	solo rocchetta	10	2,200



Sturalavandino in gomma nera tipo pesante

Black rubber plunger heavy type

cod.	misura	pz. x conf.	euro cad.
1321000000	Ø 120 mm	10	5,600
1322000000	Ø 150 mm	10	6,700



Sturalavandino in gomma rossa

Red rubber plunger

cod.	misura	pz. x conf.	euro cad.
1321R00000	Ø 120 mm	10	3,712
1322R00000	Ø 150 mm	10	5,400



Sturalavandino tipo brevettato

Patented type plunger

cod.	pz. x conf.	euro cad.
1323000000	6	19,750



Disotturatore Pango ad aria compressa

Plug remover Pango with compressed air

cod.	pz. x conf.	euro cad.
5025000000	1	53,760



Trafilato retrolavello in materiale plastico bianco

White plastic drawn back to sink

cod.	misura	mt x conf.	euro al mt
1318000000	25 ml	25 ml	3,348



Sgombratubo in filo d'acciaio ricoperto, con manovella e spirale tipo lusso

Stainless plug remover with crank and spiral luxury model

cod.	Ø 7 mm	pz. x conf.	euro cad.
1320L00150	150 cm	1	3,800
1320L00250	250 cm	1	4,600
1320L00350	350 cm	1	5,600
1320L00500	500 cm	1	7,320
1320L00700	700 cm	1	9,400
1320L01000	1000 cm	1	12,920



Sgombratubo in filo d'acciaio

Stainless plug remover

cod.	Ø 8 mm	pz. x conf.	euro cad.
1320000250	250 cm	1	4,350
1320000350	350 cm	1	4,950
1320000500	500 cm	1	6,250
1320000700	700 cm	1	8,980
1320001000	1000 cm	1	12,550



Idrotrade spa
div. **Idronord**

sede legale:
via della Madonna, 2
24040 Lallio (BG)

uffici e magazzino:
via delle Industrie, 83
20040 CAMBIAGO (MI)

tel. 02 95308252
fax 030 2659968
info@idronord.it

www.idronord.it